

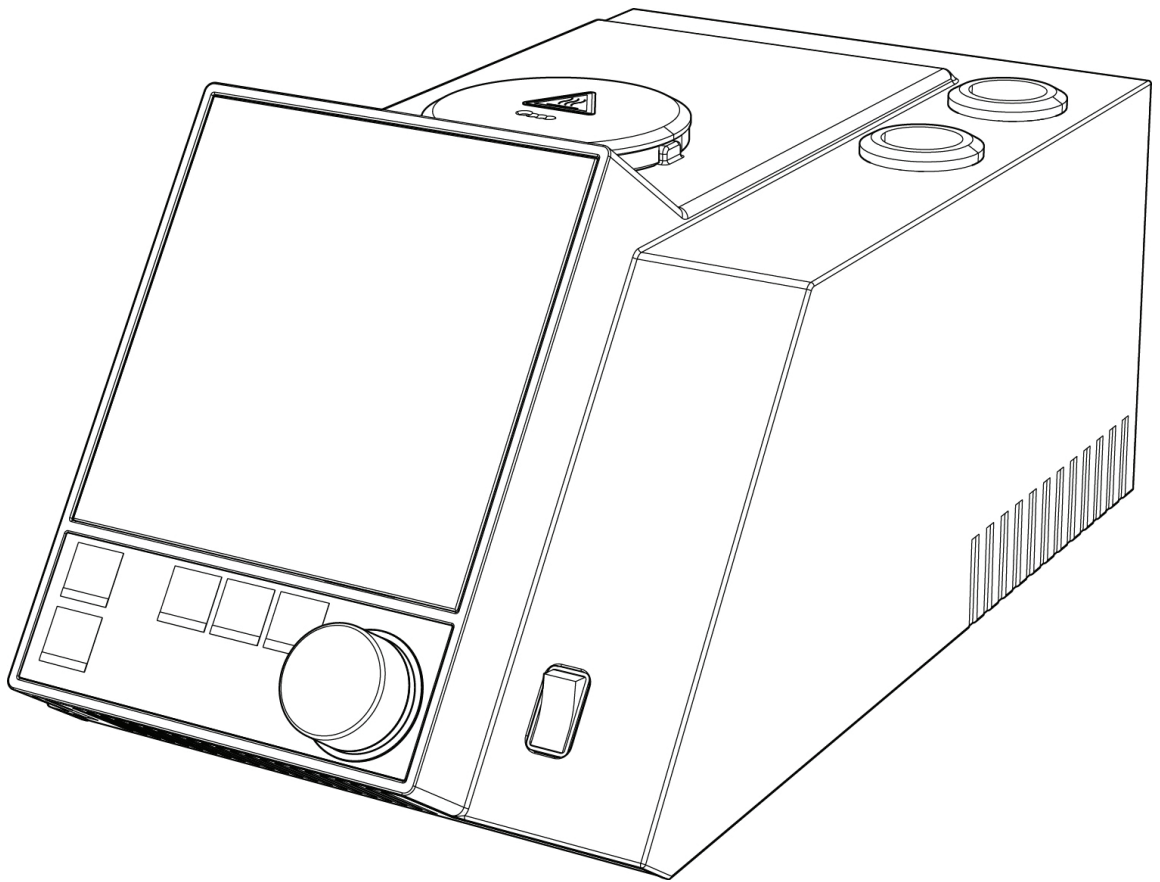

# Melting Point M-565

## Operation Manual



093256l en

## **Imprint**

Product Identification:  
Operation Manual (Original), Melting Point M-565

093256l en

Publication date: 10.2019

BÜCHI Labortechnik AG  
Meierseggstrasse 40  
Postfach  
CH-9230 Flawil 1

E-Mail: [quality@buchi.com](mailto:quality@buchi.com)

BUCHI reserves the right to make changes to the manual as deemed necessary in the light of experience; especially in respect to structure, illustrations and technical detail.

This manual is copyright. Information from it may not be reproduced, distributed, or used for competitive purposes, nor made available to third parties. The manufacture of any component with the aid of this manual without prior written agreement is also prohibited.

## Table of contents

1	About this manual . . . . .	5
1.1	Reference documents . . . . .	5
1.2	Abbreviations . . . . .	5
2	Safety . . . . .	6
2.1	User qualification . . . . .	6
2.2	Proper use . . . . .	6
2.3	Improper use . . . . .	6
2.4	Warning notices used in this manual . . . . .	7
2.5	Product safety . . . . .	7
2.5.1	Instrument-related hazards . . . . .	7
2.5.2	Other hazards . . . . .	7
2.5.3	Safety measures . . . . .	8
2.5.4	Safety elements . . . . .	8
2.6	General safety rules . . . . .	8
3	Technical data . . . . .	9
3.1	Scope of delivery . . . . .	9
3.1.1	Standard accessories . . . . .	9
3.1.2	Optional accessories . . . . .	11
3.2	Technical data overview . . . . .	14
3.3	Materials used . . . . .	15
4	Description of function . . . . .	16
4.1	Functional principle . . . . .	16
4.1.1	Pharmacopoeia and thermodynamic melting points . . . . .	17
4.1.2	Boiling points . . . . .	18
4.2	Controls and connections . . . . .	19
5	Putting into operation . . . . .	20
5.1	Installation site . . . . .	20
5.2	Commissioning . . . . .	20
5.2.1	Unpacking and installation . . . . .	20
5.2.2	Connecting to a PC with MeltingPoint Monitor software . . . . .	22
5.2.3	Power connection . . . . .	22
5.2.4	Calibration . . . . .	22

Read this manual carefully before installing and running your system; take particular note of the safety precautions in section 2. Keep the manual in the immediate vicinity of the instrument, so that it can be consulted at any time.

No technical modifications may be made to the instrument without the prior written agreement of BUCHI. Unauthorized modifications may affect system safety or result in accidents. This manual is copyrighted. Information from it may not be reproduced, distributed, or used for competitive purposes, nor made available to third parties. The manufacture of any component with the aid of this manual without prior written agreement is also prohibited.

The English manual is the original language version and serves as basis for all translations into other languages. Other language versions can be downloaded at [www.buchi.com](http://www.buchi.com).

6	Operation. . . . .	23
6.1	Basic operating principles . . . . .	23
6.1.1	Display during idle. . . . .	23
6.1.2	Display during a process or in menus. . . . .	24
6.1.3	Entering text . . . . .	25
6.1.4	Using the external keyboard . . . . .	26
6.2	Melting point determination . . . . .	26
6.2.1	Sample preparation . . . . .	26
6.2.2	Determination without pre-registered melting point method . . . . .	27
6.2.3	Creating a method. . . . .	30
6.2.4	Using and handling methods. . . . .	30
6.2.5	Adjusting parameters during a determination . . . . .	31
6.2.6	Printout . . . . .	31
6.2.7	Melting result. . . . .	32
6.3	Boiling point . . . . .	38
6.3.1	Sample preparation . . . . .	38
6.3.2	Determination without pre-registered boiling point method . . . . .	38
6.3.3	Creating a method. . . . .	40
6.3.4	Adjusting parameters during a determination . . . . .	40
6.3.5	Printout . . . . .	41
6.4	Calibration. . . . .	42
6.4.1	Calibration principle . . . . .	42
6.4.2	Calibration procedure . . . . .	43
6.4.3	Printout . . . . .	45
6.4.4	Verification . . . . .	46
6.5	Settings, SysInfo, Test . . . . .	46
6.5.1	Test protocol . . . . .	49
6.5.2	SysInfo protocol . . . . .	50
6.6	User Management . . . . .	52
6.7	XML to PC data export . . . . .	52
7	Maintenance. . . . .	53
7.1	Housing . . . . .	53
7.2	Glass window . . . . .	53
7.3	Upkeep. . . . .	53
7.4	Cleaning the heating block . . . . .	54
8	Troubleshooting . . . . .	55
8.1	Malfunctions and their remedy. . . . .	55
8.1.1	Setting the printer baud rate . . . . .	57
8.2	Customer service. . . . .	57
9	Shutdown, storage, transport, and disposal . . . . .	58
9.1	Storage and transport . . . . .	58
9.2	Disposal . . . . .	58
10	Spare parts. . . . .	59
11	Declarations and requirements . . . . .	60
11.1	FCC requirements (for USA and Canada). . . . .	60



# 1 About this manual

This manual describes the Melting Point M-565 and provides all the information required for the safe operation and to maintain it in good working order.

It is addressed in particular to laboratory personnel and operators.

## NOTE

The symbols pertaining to safety (WARNINGS and ATTENTIONS) are explained in section 2.

## 1.1 Reference documents

For more information regarding melting point, refer to the corresponding literature:

- The Laboratory Assistant 94187
- Melting Point M-560, Operating Manual numbers 93251–93255
- Melting Point M-565, Operating Manual numbers 93256–93260

## 1.2 Abbreviations

### Chemicals:

PTFE	Polytetrafluoroethylene
PP	Polypropylene
PE	Polyethylene
EPDM	Ethylene-propylene-diene rubber
POM	Polyoxymethylen
PUR	Polyurethane

### Miscellaneous:

mp	Melting point
bp	Boiling point
pharm.	Pharmacopoeia
therm.	Thermodynamic
L	Sample left
C	Sample center
R	Sample right

## 2 Safety

This section highlights the safety concept of the Melting Point M-565, Sample Loader M-569 and the MeltingPoint Monitor software and contains general rules of behavior and warnings about hazards concerning the use of the product.

The safety of users and personnel can only be ensured if these safety instructions and the safety-related warnings in the individual sections are strictly observed and followed. Therefore the manual must always be available to all persons performing the tasks described herein.

### 2.1 User qualification

The instrument may be used only by laboratory personnel or other persons whose training or professional experience give them an overview of the dangers which can develop when operating the instrument.

Personnel without this training or persons who are currently being trained require careful supervision. This Operation Manual serves as a basis for training.

### 2.2 Proper use

The instrument has been designed and built for laboratory use only. It is intended to be used to determine melting and boiling points and melting ranges at ambient temperatures up to 400 °C.

### 2.3 Improper use

Applications beyond the described above are improper. Furthermore, applications which do not comply with the technical data are also considered improper. The operator bears the sole risk for any damages caused by such improper use.

The following applications in particular are expressly forbidden:

- Use in rooms requiring explosion-proof equipment.
- Extraction of samples which may explode or ignite as the result of a blow, friction, heat, or spark (e.g. explosives, et cetera).

## 2.4 Warning notices used in this manual



### WARNING

Generally, the triangular warning symbol indicates the possibility of personal injury or even loss of life if the instructions are not followed.



### WARNING

Hot surface.



### WARNING

Electrical hazard.



### WARNING

Biohazard.



### ATTENTION

The "read this" symbol for ATTENTION indicates that equipment damage, malfunctions, or incorrect processes may result if the instructions are not followed.

### NOTE

Useful tips to facilitate operation of the instrument.

## 2.5 Product safety

The Melting Point M-565, Sample Loader M-569, and the MeltingPoint Monitor software are designed and built in accordance with current state-of-the-art technology. However, risks to users, property, and the environment can arise when the instrument is used carelessly or improperly.

The manufacturer has determined residual dangers emanating from the instrument

- if the instrument is operated by insufficiently trained personnel.
- if the instrument is not operated properly.

Appropriate warnings in this manual serve to alert the user to these residual dangers.

### 2.5.1 Instrument-related hazards

Pay attention to the following safety notices:



### WARNING

Potentially hot surfaces during operation, especially the heating oven (up to 400 °C).

- Always be aware of the danger of being burned.

### 2.5.2 Other hazards



### WARNING

Certain solvents within or in the vicinity of the Melting Point M-565 can form peroxides and/or are highly inflammable.

- Always be aware of the explosion risk when working with hazardous substances or with substances of unknown composition.
- Always use the instrument in an adequately ventilated work area.

### 2.5.3 Safety measures



Always wear personal protective equipment such as protective goggles and protective clothing, when working with the instrument.



### 2.5.4 Safety elements

#### Anti-seismic tie-down

- The instrument is equipped with a fixture to tie it down in the event of an earthquake (see bottom side of the instrument).

## 2.6 General safety rules

#### Responsibility of the operator

The head of laboratory is responsible for training the lab personnel.

The operator shall inform the manufacturer without delay of any safety-related incidents that occur during the operation of the instrument. Legal regulations, such as local, state, and federal laws applying to the instrument, must be strictly followed.

#### Duty of maintenance and care

The operator is responsible for ensuring that the instrument is operated only in a proper manner and that maintenance, service, and repairs are performed with care, on schedule, and by authorized personnel only.

#### Spare parts to be used

Use only recommended consumables and spare parts for maintenance in order to ensure continued optimum system performance and reliability. Modifications to the spare parts used are allowed only with the prior written permission of the manufacturer.

#### Modifications

Modifications to the instrument are permitted only after prior consultation with and written approval from the manufacturer. Modifications and upgrades should be carried out only by an authorized BUCHI technical engineer. The manufacturer reserves the right to decline any claim resulting from unauthorized modifications.

## 3 Technical data

This section introduces the reader to the Melting Point M-565 and its main components. It contains technical data, requirements, and performance data.

### 3.1 Scope of delivery

Check the scope of delivery according to the order number.

#### NOTE

For detailed information on the listed products, see [www.buchi.com](http://www.buchi.com) or contact your local dealer.

#### 3.1.1 Standard accessories

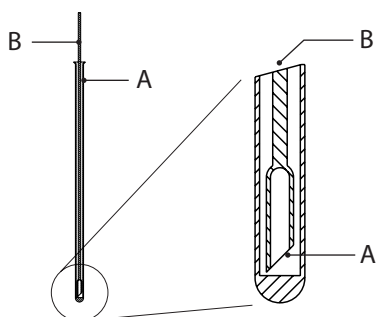
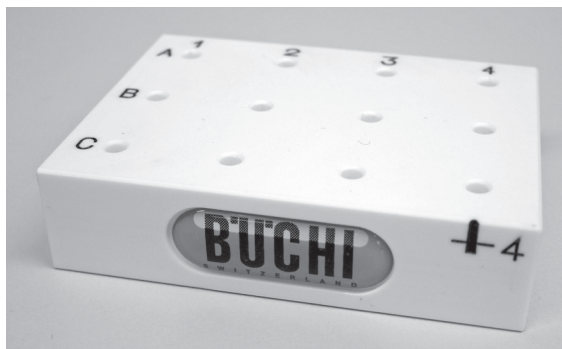

**Table 3-1: Standard accessories**

Product	Ordernumber
Melting Point M-565	11058004

Calibration set M-560 / M-565 (4 substances; 4-nitrotoluene, diphenyl acetic acid, caffeine, potassium nitrate)	11055018
--	----------

Melting point capillaries, 100 units	017808
--------------------------------------	--------

**Table 3-1: Standard accessories (cont.)**

Product	Ordernumber
Sample holder	11055014

Cleaning tool	051978
---------------	--------

A) Boiling point tubes, 10 units	019697
----------------------------------	--------

B) Boiling point capillaries, 10 units	051850
--	--------

## 3.1.2 Optional accessories

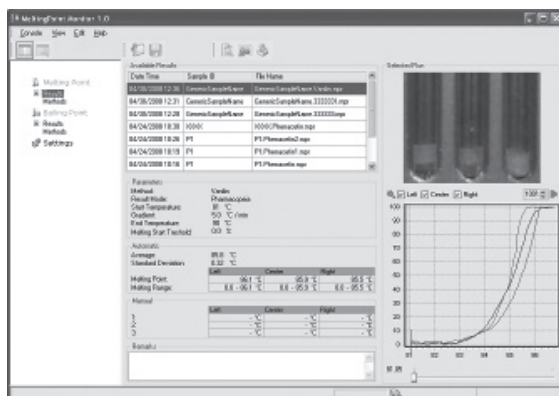
**Table 3-2: Optional accessories**

Product	Ordernumber
MeltingPoint Monitor software with license	11055332



Sample Loader M-569	051997
---------------------	--------



Verification set M-560 / M-565 (3 substances; benzil, p-anisic acid, phenolphthalein)	11055019
---	----------

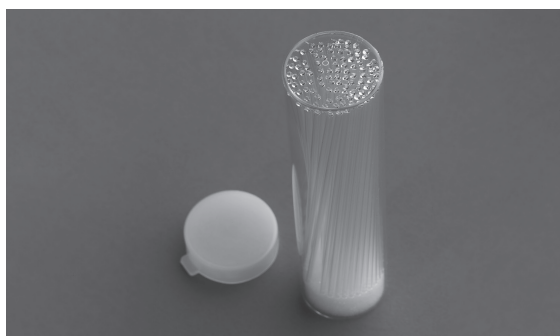

Melting point capillaries, 1000 units	001759
---------------------------------------	--------

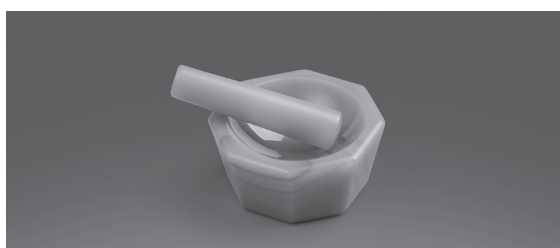

Mortar and pestle, agate	041867
--------------------------	--------

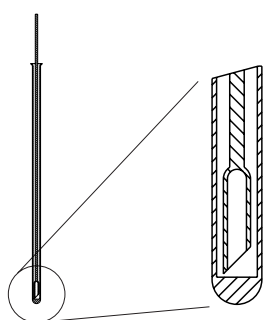
**Table 3-2: Optional accessories (cont.)**

Product	Ordernumber
Compact keyboard German (CH)	029509
Compact keyboard English (USA)	029508
Serial dot matrix printer (including ribbon, paper roll, and cables)	11069766
Ribbon for printer (SP512)	044306
Ribbon for printer (SP712)	11069767
Paper roll for printer	038684
A) Boiling point tubes, 100 units	019007
B) Boiling point capillaries, 100 units	051890
User management activation code	11066387
Protective cover	051935
Compaction wire	036721
CD Demo Melting Point Monitor	051983
USB cable, 2.0 m	11055310
Operation Manual:	
English	93256
German	93257



**Table 3-2: Optional accessories (cont.)**

Product	Ordernumber
IQ/OQ: After installation	
OQ: For repeat use	
For further information please contact your local affiliate or distributor.	
IQ/OQ M-565 English	11055 004
OQ M-565 English	11055 009

## 3.2 Technical data overview

**Table 3-3: Technical data of the Melting Point M-565**

Melting Point M-565	
Manual melting point determination	√
Manual boiling point determination	√
Automatic melting point determination	√
Automatic boiling point determination	√
Homogeneous sample loading	–
Positions for melting capillaries	3
Positions for boiling capillaries	1
Precision magnifying lens	√
Magnification of lens	2.5x
Digital camera	√
Video function	√
Magnification, display	6 x
Display	Colour, TFT, 320×240, 3.5"
Determination temperature range	Ambient + 10 °C to 400 °C
Temperature resolution	0.1 °C
Accuracy melting point at 0.5 °C/min	± 0.2 °C
Repeatability melting point at 0.5 °C/min	± 0.1 °C
Accuracy boiling point at 1.0 °C/min up to 400 °C	± 0,5 °C
Repeatability boiling point at 1.0 °C/min	± 0.3 °C
Temperature gradients, °C/min	0.1, 0.2, 0.5, 1, 1.5, 2, 2.5, 3, 5, 10, 20
Heat-up time (50 °C–350 °C) at 25 °C	~ 4 min
Cool-down time (350 °C–50 °C) at 25 °C	~ 13 min
Electrical supply	100–240 V (±10%), 50–60 Hz
Power consumption	150 W
Contact termination	L, N, PE
Video run time	350 min at 1 °C/min, 700 min at 0.5 °C/min
Approval	CE, CSA, UL
Dimensions (W×H×D), mm	190×200×370
Weight, kg	4.5
Environmental conditions	For indoor use only
Temperature	5–40 °C
Altitude	up to 2000 m a.s.l.
Humidity	Maximum relative humidity 80% for temperatures up to 31 °C, decreasing linearly to 50% relative humidity at 40 °C
Over voltage category	II
Degree of protection	IP 20
Pollution degree	2
Storable methods for melting point	50
Storable methods for boiling point	50

**Table 3-3: Technical data of the Melting Point M-565 (cont.)**

Melting Point M-565	
Compliant with Pharmacopeia methods	PH. EUR., USP and JP

## NOTE

Temperature measuring accuracy refers to pharmacopoeia melting point.

### 3.3 Materials used

**Table 3-4: Materials used**

Component	Material designation
Print holder	PA
Heating block	Aluminium
Lenses	Glass
Axial fan	Aluminium
Housing	PU, stainless steel, glass
Cover	POM, ceramic, aluminium, stainless steel

## 4 Description of function

This section explains the basic principle of the Melting Point M-565 and provides a functional description of the assemblies.

### 4.1 Functional principle

The Melting Point M-565 is an instrument for automatic and visual (manual) determination of melting point, melting range, and boiling point at ambient temperatures +10 °C up to 400 °C. The melting point of three samples can be determined at the same time. The boiling point can be determined for one sample. Samples can be observed through the lens or on the color display.

Detection principle of the Melting Point M-565

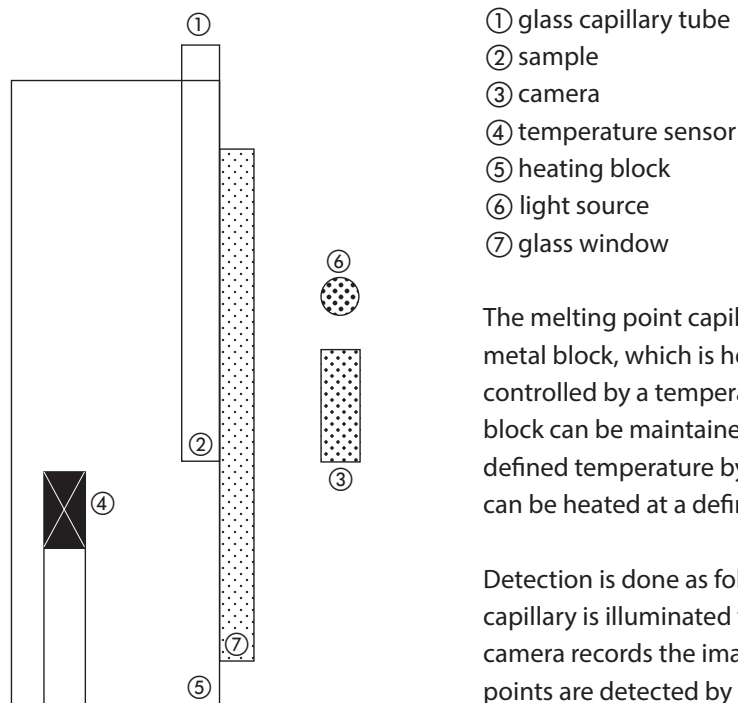

Fig. 4.1: Reflection mode due to Ph. Eur. 6.1 2.2.60.

## 4.1.1 Pharmacopoeia and thermodynamic melting points

The melting process of a substance does not take place instantaneously - it requires a finite amount of time. The melting process begins at the point where the first particles of the substance turn into the liquid state (thermodynamic melting point). The end of the melt is reached when the last solid particles have gone over into the liquid phase (pharmacopoeia melting point).

During the entire melting process of a pure compound, the temperature of the pure substance remains constant while heat is constantly transferred from the heating block to the sample.

For pure substances the thermodynamic melting point can be approached by multiplying the thermodynamic correction factor by the square root of the gradient and subtracting the result from the pharmacopoeia melting point.

$$mp_{[\text{thermodyn.}]} = mp_{[\text{pharma.}]} - (k \times \sqrt{\text{gradient}})$$

k = thermodynamic factor

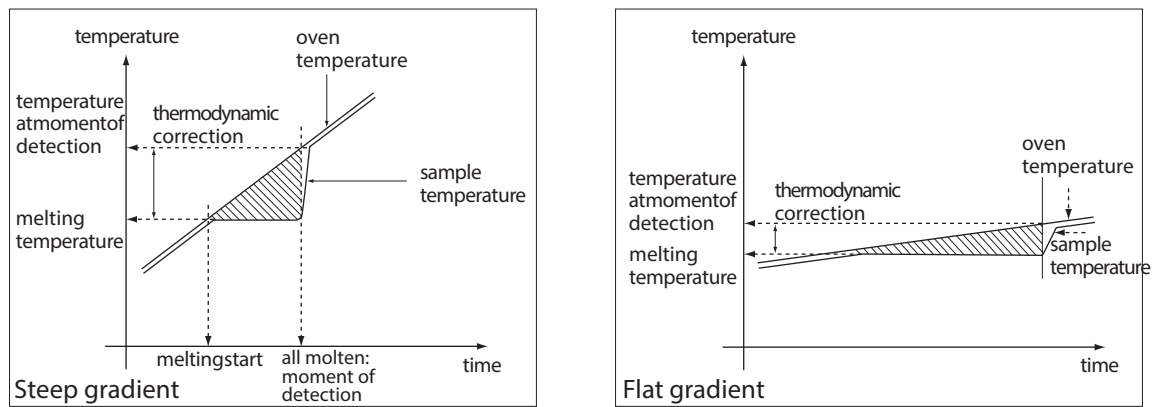

Fig. 4.2: The amount of thermodynamic correction depends on the gradient selected: The smaller the gradient, the less the correction required.

## 4.1.2 Boiling points

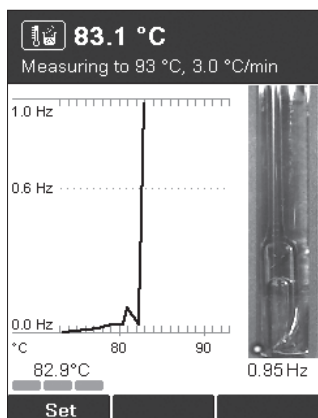

Fig. 4.3: Boiling point

The boiling point is determined by the “Siwoloboff” method.

The Melting Point M-565 can be used to determine the boiling point of a small amount of liquid. The heating block has one insert available for boiling point tubes (outside left). The moment of boiling is determined automatically or visually.

Detection is done as follows:

The beam of light illuminates the boiling point tube from the front, and the camera records the image.

The process for boiling point determination is analogous to that for determining a melting point:

- The start temperature is set 5 to 10 °C lower than the expected boiling point.
- The sample is put into the heating block as soon as the start temperature is reached.
- A delay time allows the equilibrium between sample oven temperature and sample temperature. During this delay time some air bubbles turn out of the boiling point capillary.
- Starting from the start temperature, the sample is heated at a temperature gradient of 1 °C/min.
- As the temperature rises, bubbles of gas rise slowly and regularly from the immersed end of the boiling point capillary.
- The boiling point of the liquid has been reached when the flow of steam bubbles reaches a frequency of 0.6 Hz [Hertz].

The instrument records the curve and displays the result. At the beginning of the measurement, the current pressure has to be entered to obtain correct results. The system detects the boiling temperature. The boiling point is calculated and corrected for current pressure.

## 4.2 Controls and connections



Fig. 4.4: Front view

- ① Power switch; turns the instrument on/off
- ② Start; starts process
- ③ Stop; stops process, starts/stops ventilation, returns to idle screen
- ④ 3 Select and Set buttons
- ⑤ Rotary knob for navigation in the menu and for select characters
- ⑥ Display

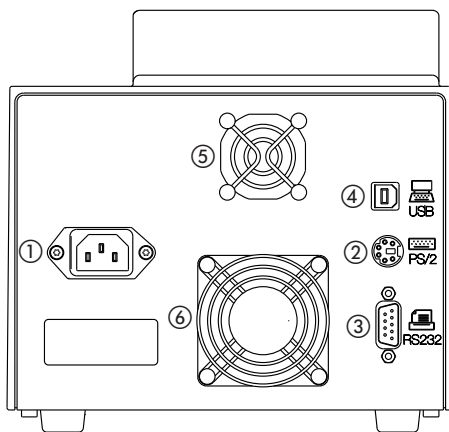

Fig. 4.5: Rear view

- ① Mains plug
- ② PS/2 connection for keyboard
- ③ RS 232 connection for serial printer
- ④ USB connection to the PC if software Melting Point Monitor is used, needed for service
- ⑤ Housing cooling fan
- ⑥ Heating block cooling fan

## 5 Putting into operation

This section describes the installation of the Melting Point M-565 and gives instructions for initial start-up.

### NOTE

Inspect the instrument for damage during unpacking. If necessary, prepare a status report immediately to inform the postal company, railway company, or transport company. Keep the original packaging for future transport.

### 5.1 Installation site

Place the instrument on a stable, horizontal surface adequate for the maximum product dimensions. It is advisable to place the instrument in a fume hood due to the fact that it will be used to measure chemical substances. For safety reasons and to ensure sufficient cooling in the electronic compartment, of the unit must be placed at least 30 cm away from rear walls or other objects. No containers, chemicals, or other appliances should be placed behind the unit.

### NOTE

Do not expose the instrument to direct sunlight or very high illumination. This could influence the automatic detection process.

General hazards arise from:

- Mixtures of unknown composition or contaminations
- Combustible gases or solvent vapors in the immediate vicinity of the unit
- Damaged glass components
- Insufficient distance from back of the unit to the wall
- Burning by touching hot parts of the heater

### 5.2 Commissioning

#### 5.2.1 Unpacking and installation

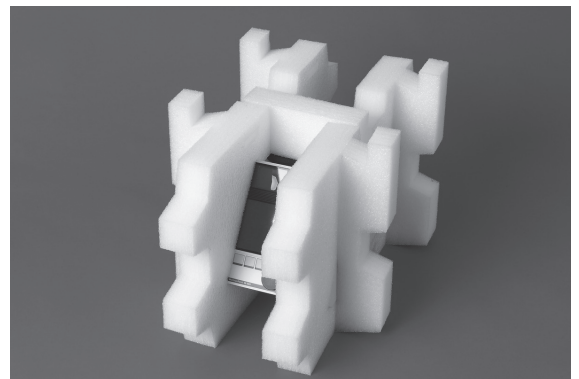
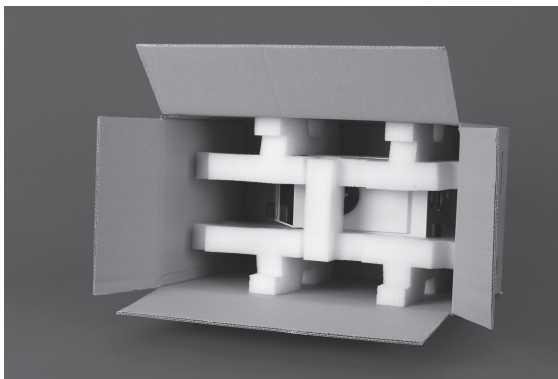

- Unpack the instrument and place it on a table. Remove the packing, and make sure that the following parts are installed:





- Glass window

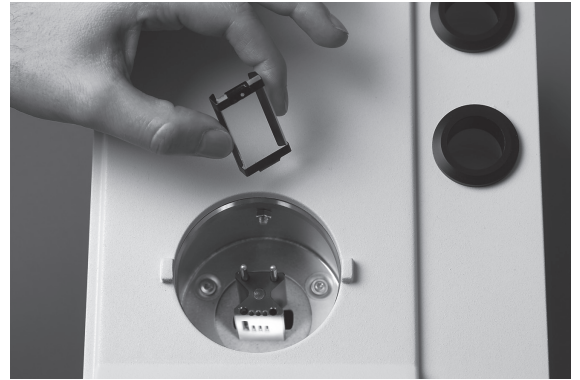

- Glass window with glass holder



- Install the glass window with glass holder on the front side of the heating block.
- Press the glass holder down.



- Install the cover.

#### Accessories



- Place the melting point capillaries in the hole of the housing. The second hole is a reservoir for used capillaries.

### 5.2.2 Connecting to a PC with MeltingPoint Monitor software



The Melting Point M-565 can be operated in connection with the MeltingPoint Monitor software. In this case, connect the instrument with the PC or laptop using the USB cable. For detailed information check installation guide on software CD.

- ① Melting Point M-565
- ② Laptop or PC with MeltingPoint Monitor software

Fig. 5.1: Connection of Melting Point M-565 with the MeltingPoint Monitor software.

#### NOTE FOR USER MANAGEMENT

The software is not intended for use in the user level of the optional user management (11066387). The melting point instrument blocks the connection to the software. In the administrator mode the connection is possible.

### 5.2.3 Power connection

#### ATTENTION



Make sure that the voltage of the socket corresponds to the voltage given on the type plate of the instrument. Ensure that the instrument is grounded. External connections and extension cables must be provided with a grounded conductor lead (3-pole couplings, cable, or plug equipment) as the mains lead has a molded plug to avoid risks due to inadvertently defective wiring. Make sure that no electric sparks form in the instrument or its surroundings as they might damage the instrument. Make sure that the mains connector is freely accessible at any time.

### 5.2.4 Calibration

#### NOTE

Before use it is recommended to calibrate the apparatus. Use of supplied calibration substances is recommended. Calibration is carried out in accordance with section 6.4 of these operating instructions.

## 6 Operation

This section explains the operating elements and possible operating modes. It gives instructions on how to operate the Melting Point M-565 properly and safely.

### ATTENTION



Before use it is recommended to calibrate the apparatus. Use supplied calibration substances only. The calibration mode is described in section [6.4 Calibration].

### 6.1 Basic operating principles



#### WARNING

The heating oven can reach temperatures up to 400 °C.

#### 6.1.1 Display during idle

After switching on, the display shows the menu for melting point.

① Function category with main setting parameters

② Hint

③ Parameters used after pressing START

④ Shows current heating block temperature and time

⑤ Functions selectable by the keys below

Different menus can be accessed by turning the rotary knob. Each menu has its own symbol. These idle screens are the starting points for all actions. The corresponding symbol is displayed during all processes.

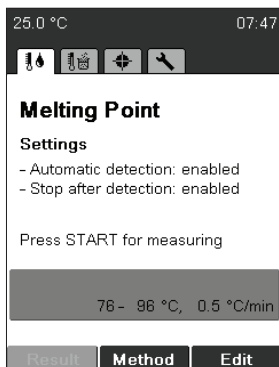

Melting Point

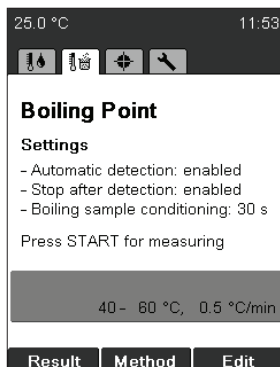

Boiling Point

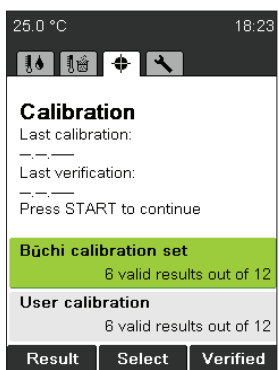

Calibration



Tools

6.1.2 Display during a process or in menus

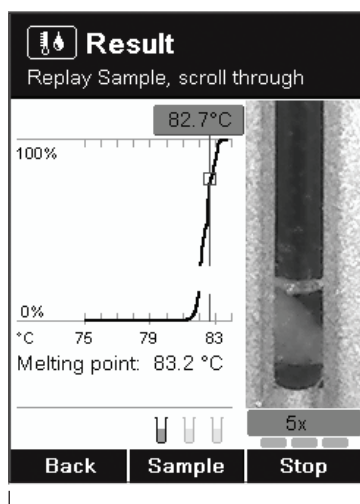

③

- ① Shows where you are and gives hints and instructions.
- ② Working area shows:
  - items to select
  - samples during measurement
  - specific information in connection with the current menu
- ③ Functions selectable by the keys below.

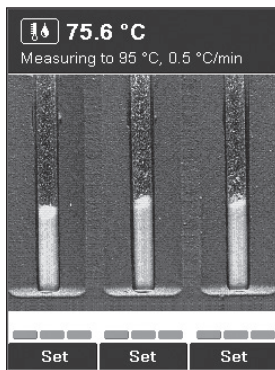

Screen during melting point determination

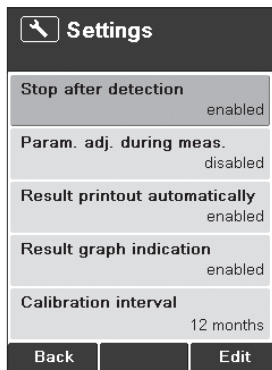

Settings menu

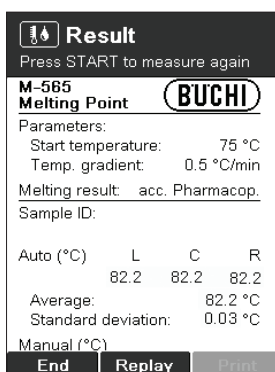

Result indication (numeric result)

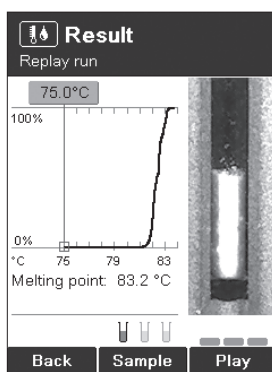

Result indication (replay)

### 6.1.3 Entering text



Text can be entered by using the rotary knob or an external keyboard.

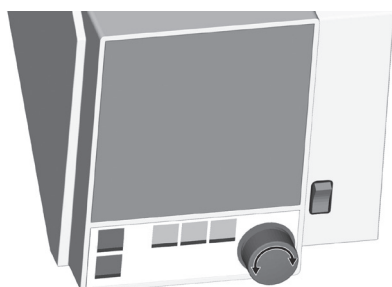

Rotary knob:

- Turn the rotary knob to select a character and press Enter. Press Save after entering all characters.

### 6.1.4 Using the external keyboard

#### NOTE

The instrument can be operated using an external keyboard.

For the softkeys, the following keys of the external keyboard are assigned:

- ENTER = right softkey
- Alt = center softkey
- Esc = left softkey
- In the method menu: To navigate quickly to a method name press the initial letter.

## 6.2 Melting point determination

#### NOTE

For exact melting point determination, use original capillaries from BUCHI only. If other capillaries are used, the results can be wrong. Use the following items:

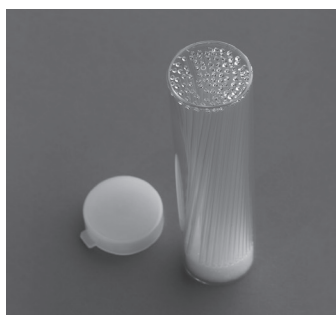

Fig. 6.1: Melting point capillaries

Product	Order number
Melting point capillaries, 100 units	017808
Melting point capillaries, 1000 units	001759

### 6.2.1 Sample preparation

#### NOTE

Use only capillaries from BUCHI. They are precise and adequate for this kind of operation. Other capillaries have other dimensions and wall thicknesses. Using others may result in results that are incorrect.

Each sample has to be prepared.

The following methods to compact the samples are recommended:

- Using the Sample Loader M-569
- Knocking the capillaries on a hard surface.

#### NOTE

Sample preparation by letting the capillaries fall through a tube is not advised, because cross contamination may occur.

Preparation of the samples:

- The samples being investigated must be fully dry, homogenous, and in powdered form. Moist samples must be dried first (the pharmacopoeias prescribe that the substance needs to be dried in a vacuum for 24 hours over silica gel R). Coarse crystalline samples and non-homogeneous samples are finely ground in a mortar.
- To fill the capillary tubes with the sample, the open ends of the tubes are pressed into the substance. The substance is moved to the bottom of the tubes by repeatedly pounding the tubes against a hard base.
- Enough substance must be filled into the glass capillary to form a compact column 4 to 6 mm in height. (A height of 4–5 mm is recommended for precision measurements.) To ensure comparable results, it is important to fill all three capillary tubes to the same height and to compact the substance well in the tubes using the Sample Loader M-569.

### 6.2.2 Determination without pre-registered melting point method

- Choose the menu for melting point determination.
- Make sure that all samples are removed.
- Press START to start the determination process immediately with the last parameters used.

#### NOTE

If the current parameters do not meet your needs, press Edit and set start temperature, stop temperature, and temperature gradient.

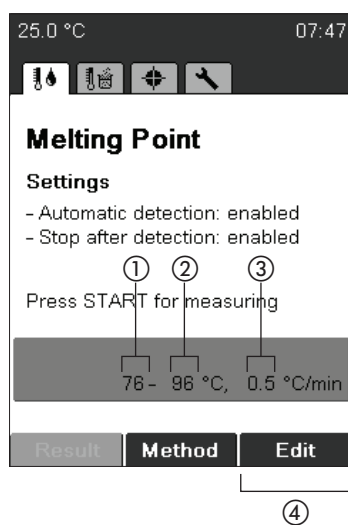

- ① Start temperature
- ② Stop temperature
- ③ Temperature gradient
- ④ Edit

- To adjust the desired melting parameters, press Edit.

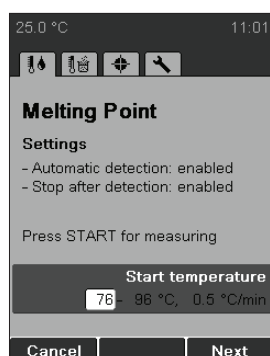

- Chose start temperature with the rotary knob, and press Next.

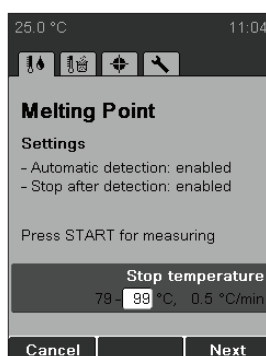

- Chose stop temperature with the rotary knob, and press Next.

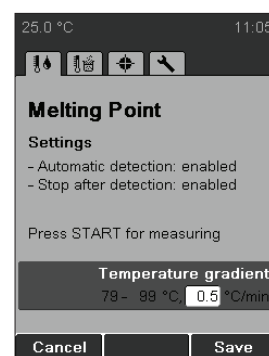

- Chose temperature gradient with the rotary knob, and press Save.

## NOTE

Insert samples only when the start temperature is reached (as soon as prompted).

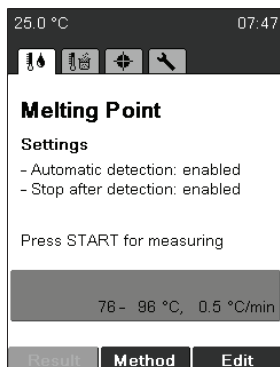

- Press START to start the determination, and follow the instructions on the screen.



The instrument requests a sample ID during preheating (for details on entering text see 6.1.3). This request can be switched off by changing the setting "Sample ID request" (see 6.5).

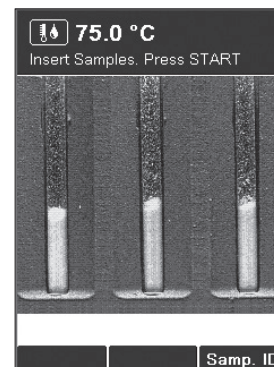

- Insert samples and press START to start the determination.

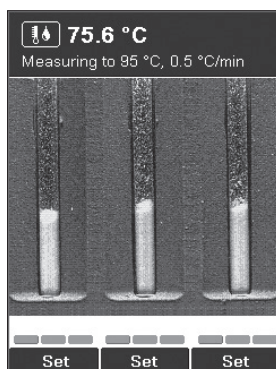

- To register additional temperature stamps, manually press the SET button for the related sample. Each button can be pressed three times. Registered temperature stamps are displayed in green.

## NOTE

The result is indicated automatically after the melting point of each sample is detected.



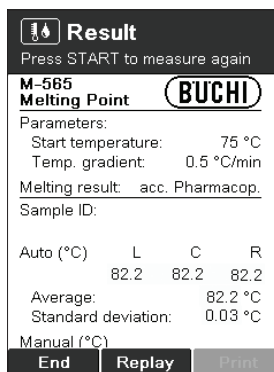

- To run through the results, turn the rotary knob up and down.
- To replay the recorded melting process, press **Replay**.
- Press **End** or **STOP** to return to the idle screen.
- Press **START** to measure again with the identical measuring parameters.
- The result is printed out automatically if a printer is connected.

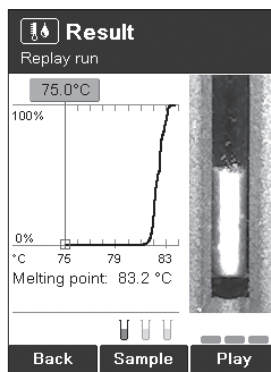

- **Back**: Turns back to the result menu.
- **Sample**: Switches between sample left, middle, and right.
- **Play**: Replays recorded video automatically.
- **Rotary knob**: Changes temperature value and its corresponding picture of the sample.

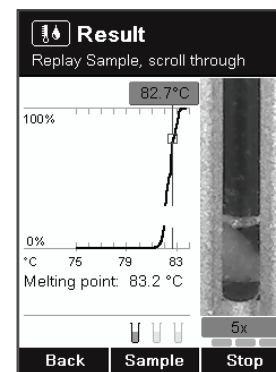

- Changes replay speed of video using rotary knob.
- **Stop**: Stops replay mode.

#### NOTE

The last result is stored in the device until a new measurement is started or the instrument is switched off.

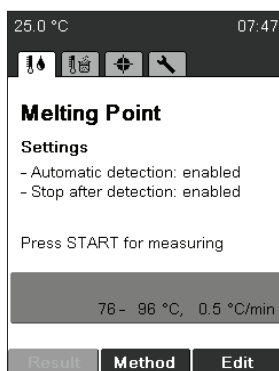

- After turning back to idle, the last result can be checked again by pressing **Result**.

6.2.3 Creating a method

Instead of entering and using the parameters directly from the idle screen, it is also possible to store parameter sets as methods.

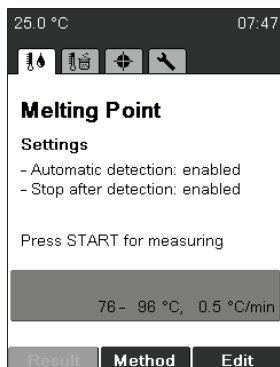

- To enter the method menu, press Method.



- To create a new method, press Options → New then OK.

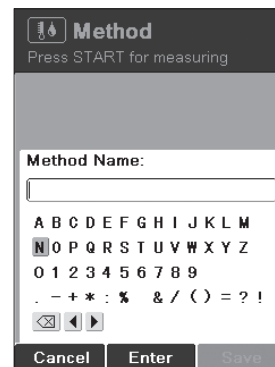

- Enter a method name. To finish press Save.



- Adjust a parameter and press Next. Then Save.

NOTE FOR USER MANAGEMENT

Creating a method is not possible when operating the instrument in the user level.

6.2.4 Using and handling methods

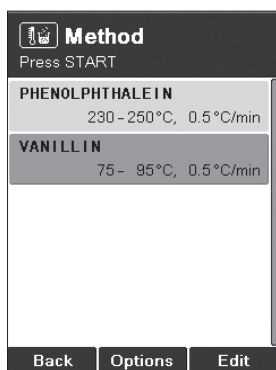

- Turn the rotary knob to select a method.
- Press START to start the determination.
- Use Edit to adjust method parameters.
- Press the Options key to get further functions:
  - New: Creates a new method.
  - Delete: Deletes the method.
  - Rename: Changes the method name.

#### NOTE FOR USER MANAGEMENT

Methods can only be started in the user level. All other actions are not possible.

### 6.2.5 Adjusting parameters during a determination

#### NOTE

Measuring parameters can be modified during preheating or a determination. This function is possible only if enabled by the setting "Param. adj. during meas." (see 6.5).

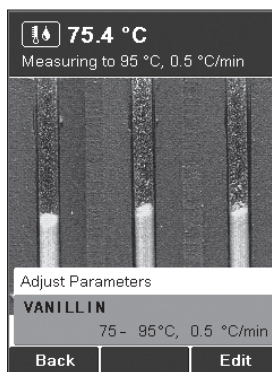

- Turn the rotary knob to display the current parameter set.
- Adjust the parameters by pressing Edit. Adjusting the parameters does not affect the saved method.

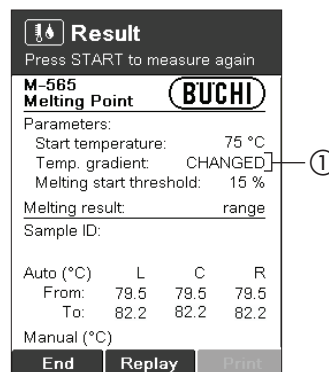

If the temperature gradient is changed during a measurement, the result shows CHANGED (①) for the temperature gradient.

### 6.2.6 Printout

#### NOTE

The result is printed out automatically if a printer is connected and automatic printing is configured in the settings menu.

## 6.2.7 Melting result

## NOTE

Changing the determination mode does not affect the principle of measurement, but it does influence the interpretation and the appearance of the results. The mode can be selected in the settings menu.

The default and most frequently used mode is the pharmacopoeia melting point. Melting range is convenient for substances with a wide melting range. The thermodynamic melting point should be used for special application only. For detailed information see Section 4.1.1.

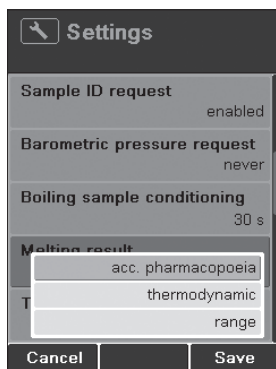

- In the settings, change the melting result to Melting point pharmacopoeia and press Save.

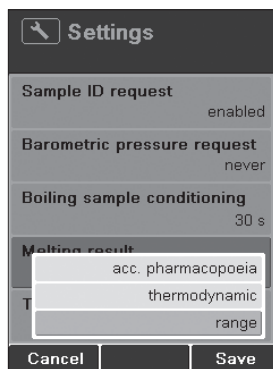

- In the settings, change the melting result to Melting range and press Save.

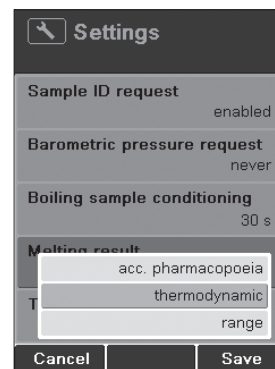

- In the settings, change the melting result to Melting point thermodynamic and press Save.

## Melting point pharmacopoeia

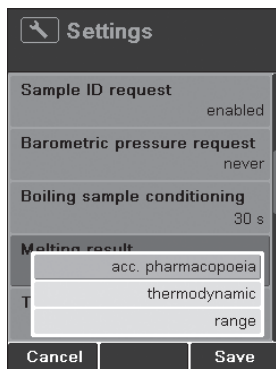

- In the settings, change the melting result to Melting point pharmacopoeia and press Save.

① <b>M-565 Melting Point</b> <b>BUCHI</b>	
Method: VANILLIN	
② Start temperature: 75 °C	
Temp. gradient: 0.5 °C/min	
Melting result: Pharmacopoeia	
Sample ID: 14.56	
③	
Auto (°C)	L C R
	82.2 82.2 82.2
Average pharm.:	82.2 °C
Standard deviation:	0.03 °C
④ Manual (°C)	
1:	___ ___ ___
2:	___ ___ ___
3:	___ ___ ___
⑤ Sample left: 82.2 °C	
⑥ Sample center: 82.2 °C	
⑦ Sample right: 82.2 °C	
⑧	
Date:	09.10.2008
Time:	11:20
Last calibration:	08.10.2008
Last verification:	08.10.2008
⑨ <b>Date, Signature:</b>	
SN:	V 00.22

## Printout

- ① Instrument type
- ② Determination parameters
- ③ Automatically detected results
- ④ Manual results
- ⑤ Curve sample left
- ⑥ Curve sample center
- ⑦ Curve sample right
- ⑧ General information
- ⑨ Signature of person making the determination

## NOTE

The Average is calculated on the basis of the temperature values with two positions after the decimal point. Thus, the value indicated for the Average might deviate from the value you calculate on the basis of the temperature values on the printout, as there is just one position after the decimal point.

6.2.7.2 Melting range

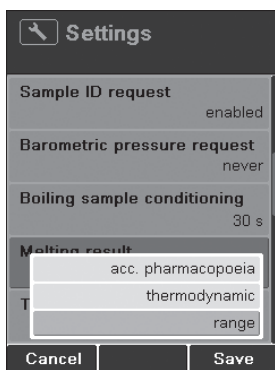

- In the settings, change the melting result to Melting range and press Save.

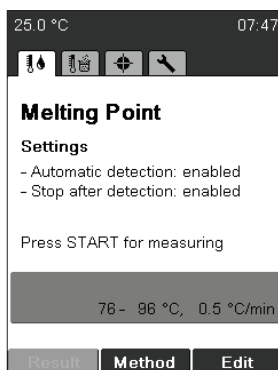

An additional parameter is shown. The default value is set to 15%. This value can be used for most of substances.

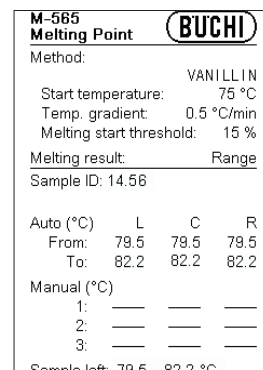

Threshold: This value is needed only for melting range determination. The default value is set to 15%. This value can be used for 80% of substances.

- If the beginning of the melting range differs from that observed, increase or decrease this value.

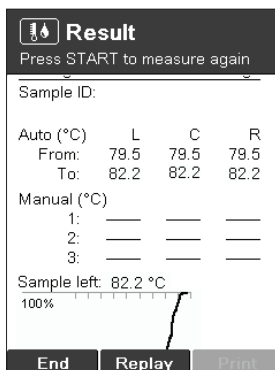

The result mode shows a range for each sample: XX.X-XX.X °C

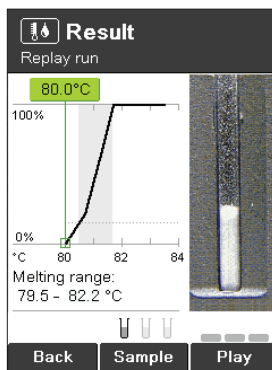

In the replay mode, the melting range is shown in gray backlit.

① **M-565 Melting Point** **BUCHI**

Method: VANILLIN

② Start temperature: 75 °C  
Temp. gradient: 0.5 °C/min  
Melting start threshold: 15 %

③ Melting result: Range  
Sample ID: 14.56

Auto (°C)	L	C	R
From:	79.5	79.5	79.5
To:	82.2	82.2	82.2

④ Manual (°C)  
1: \_\_\_\_\_  
2: \_\_\_\_\_  
3: \_\_\_\_\_

⑤ Sample left: 79.5 - 82.2 °C  
100%  
0%  
°C 75 79 83

⑥ Sample center: 79.5 - 82.2 °C  
100%  
0%  
°C 75 79 83

⑦ Sample right: 79.5 - 82.2 °C  
100%  
0%  
°C 75 79 83

⑧ Date: 09.10.2008  
Time: 11:23  
Last calibration: 08.10.2008  
Last verification: 08.10.2008

⑨ **Date, Signature:**  
\_\_\_\_\_  
SN: V 00.22

## Printout

- ① Instrument type
- ② Determination parameters
- ③ Automatically detected results
- ④ Manual results
- ⑤ Curve sample left
- ⑥ Curve sample center
- ⑦ Curve sample right
- ⑧ General information
- ⑨ Signature of person making the determination

## 6.2.7.3 Melting point thermodynamic

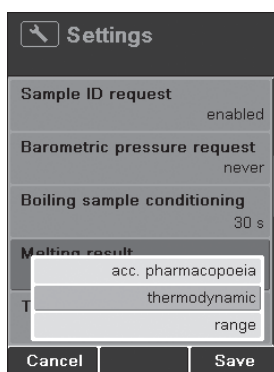

- In the settings, change the melting result to Melting point thermodynamic and press Save.

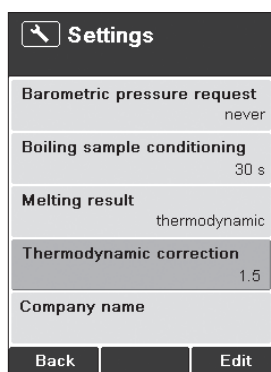

Experimental measurements have shown that in most cases a good approximation to the factor for thermodynamic correction of the BUCHI Melting Point M-565 is a value of ~1.5.

Empirical calculation for thermodynamic correction is recommended when more accurate results are required for specific substances.

In order to obtain a thermodynamic melting point result within the accuracy of the unit, the following steps are advised:

- Perform complete automatic pharmacopoeia melting point determinations on your sample at three different temperature ramping rates: 0.2, 0.5, 1.0 °C/min.
- Plot the resulting melting points versus the square root of their corresponding temperature ramping rate (mp pharmacopoeia vs.  $\sqrt{\text{gradient}}$ )—a linear dependence should be observed.
- The slope is the thermodynamic correction factor. Enter this value in the setting 6.6 “Thermodynamic correction.”

An example of this calculation procedure is shown below:

Gradient, r [°C/min]	Melting Point [°C]
0.2	236.1
0.5	236.5
1.0	236.9

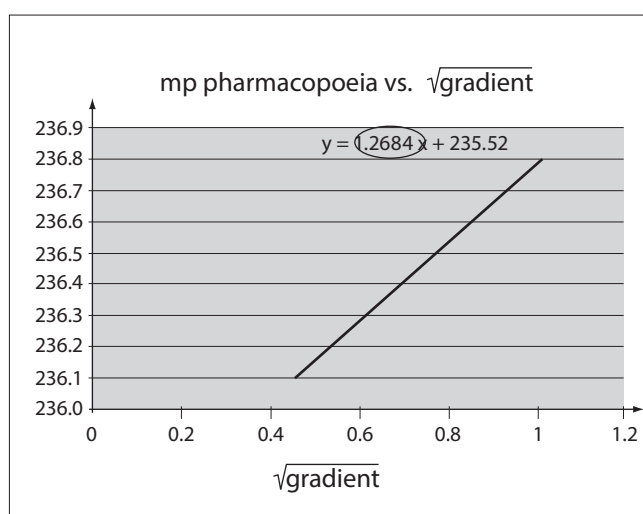

“Melting point temperature vs.  $\sqrt{\text{gradient}}$ ” for a caffeine sample melted at 0.2, 0.5, and 1.0 °C/min. The slope of the straight line, factor for thermodynamic correction = 1.3, is programmed into the setting of instrument for this compound.

Fig. 6.2: “Melting point temperature vs.  $\sqrt{\text{gradient}}$  ”



M-565 Melting Point		BUCHI	
①	Method: VANILLIN		
②	Start temperature:	75 °C	
	Temp. gradient:	0.5 °C/min	
④	Melting result: Thermodynamic		
	Thermodynamic correction:	1.5	
	Sample ID: 14.56		
③	Auto (°C)	L	C
		82.2	82.2
	Average thermodyn.:	82.2 °C	
	Standard deviation:	0.03 °C	
④	Manual (°C)		
	1:	___	___
	2:	___	___
	3:	___	___
⑤	Sample left: 82.2 °C		
⑥	Sample center: 82.2 °C		
⑦	Sample right: 82.2 °C		
⑧	Date:	09.10.2008	
	Time:	11:25	
	Last calibration:	08.10.2008	
	Last verification:	08.10.2008	
⑨	<b>Date, Signature:</b>		
	SN:	V 00.22	

## Printout

- ① Instrument type
- ② Determination parameters
- ③ Correction factor for thermodynamic determination
- ④ Automatically detected results
- ⑤ Manual results
- ⑥ Curve sample left
- ⑦ Curve sample center
- ⑧ Curve sample right
- ⑨ General information
- ⑩ Signature of person making the determination

## NOTE

The Average is calculated on the basis of the temperature values with two positions after the decimal point. Thus, the value indicated for the Average might deviate from the value you calculate on the basis of the temperature values on the printout, as there is just one position after the decimal point.

## 6.3 Boiling point

### NOTE

For exact boiling point determination, use boiling point tubes and capillaries from BUCHI only. If other glass parts are used, incorrect or no results can be obtained. Use the following items:

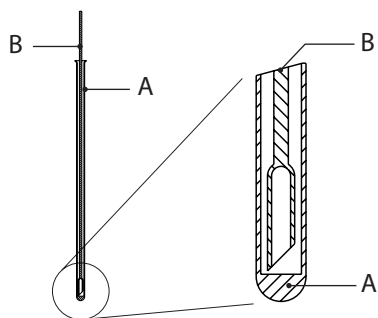

Fig. 6.3: Boiling point tube and capillary

Product	Order number
A) Boiling point tubes, 10 units	019697
A) Boiling point tubes, 100 units	019007
B) Boiling point capillaries, 10 units	051850
B) Boiling point capillaries, 100 units	051890

### 6.3.1 Sample preparation

In preparation, the boiling point tubes are filled with 5 to 10 mm of liquid sample. We recommend using a syringe for simple filling. Insert a boiling point capillary into the boiling point tube with its open/thick end down. Put the sample immediately into the heating block.

### 6.3.2 Determination without pre-registered boiling point method

- Choose the menu for boiling point determination.
- Make sure that all samples are removed.
- Press START to begin the determination process immediately with the last parameters used. They are always saved in the instrument and are indicated in the green field in the lower part of the screen.

If the current parameters do not meet your needs, press Edit and set the start temperature, stop temperature, and temperature gradient.

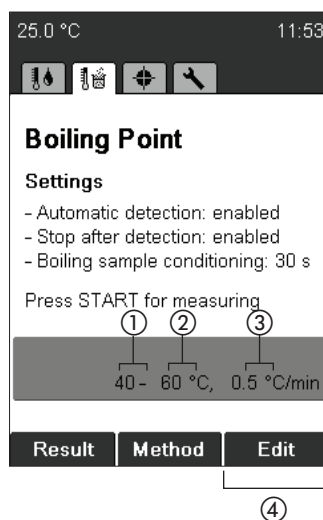

- ① Start temperature
- ② Stop temperature
- ③ Temperature gradient
- ④ Edit

- To adjust the boiling parameters, press Edit.

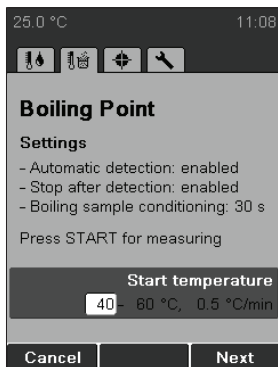

- Use the rotary knob to choose the start temperature and press Next.

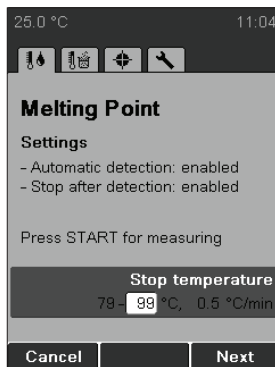

- Use the rotary knob to choose the stop temperature and press Next.

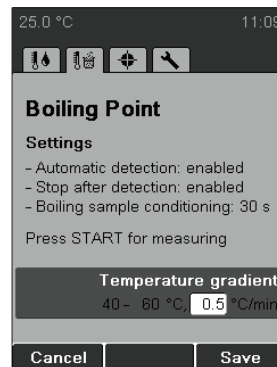

- Use the rotary knob to choose the temperature gradient and press Save.

**NOTE**

Insert sample only when the instrument has reached the start temperature.

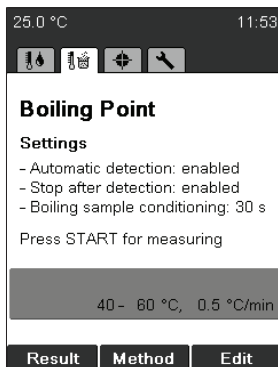

- Press START to start the determination, and follow the instructions on the screen.



- The instrument requests a sample ID during preheating (for details on entering text see 6.1.3). This request can be switched off by changing the setting "Sample ID request" (see 6.5).

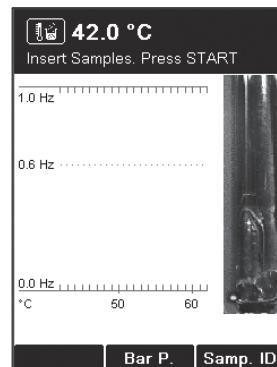

- Bar P: Enter the current barometric pressure.
- This request can be switched off by changing the setting "Barometric pressure request" (see 6.5).
- Insert sample and press START to start the determination.

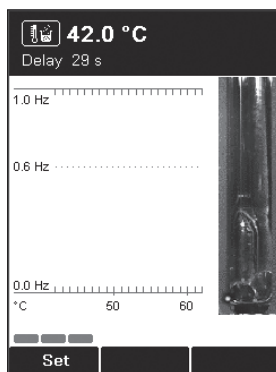

Delay: to ensure equilibrium between oven temperature and sample temperature. During this delay time some air bubbles turn out of the boiling point capillary. This request can be changed in the setting "Boiling sample conditioning" (see 6.5).

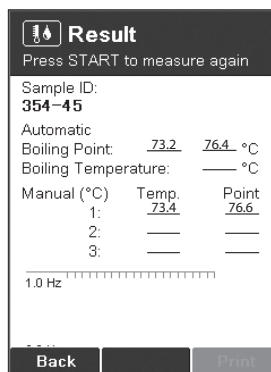

- To run through the results, turn the rotary knob up and down.
- Video replay is not available for boiling point determination.

- Press End or STOP to return to the idle screen.
- Press START to measure again with the identical measuring parameters.

### 6.3.3 Creating a method

#### NOTE

The process of creating a boiling point method is identical that used to create a melting point method (see 6.2.3).

### 6.3.4 Adjusting parameters during a determination

During preheating or a determination, measuring parameters can be modified. This function is possible only if enabled by the setting "Param. adj. during meas." (see 6.5).

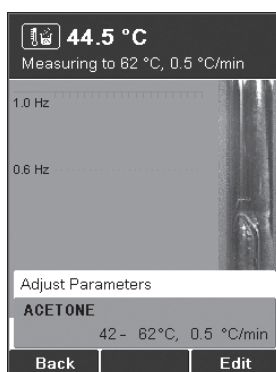

- Turning the rotary knob displays the current parameter set.
- Adjust the parameters by pressing Edit. Adjusting the parameters does not affect the saved method.

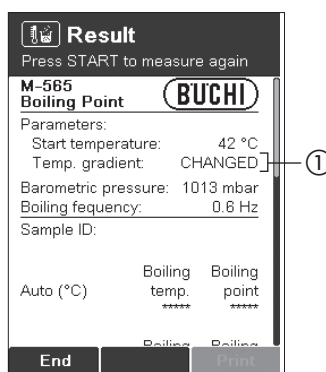

If the temperature gradient is changed during a measurement, the result shows CHANGED (①) for the temperature gradient.

When a measurement is done, the last method parameters are always retained in the instrument. To start the same method, just press START.

NOTE

Results are stored in memory until a new measurement is started or the instrument is switched off.

6.3.5 Printout

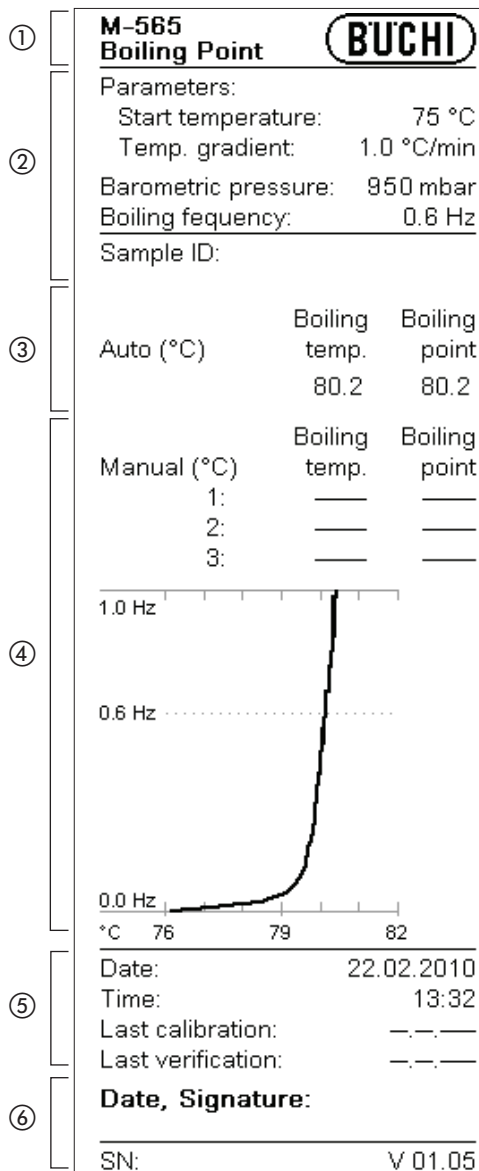

Printout

- ① Instrument type
- ② Determination parameters
- ③ Automatically detected results
- ④ Manual results
- ⑤ General information
- ⑥ Signature of person making the determination

Boiling temp.= Temperature sample boiled.

Boiling point= Boilingtemp.correctedaccordingenteredbarometric pressure.  
 If a barometric pressure of 1013 mbar is entered boiling temperature and boiling point results are equal.

## 6.4 Calibration

### NOTE

BUCHI recommends calibrating each new instrument after installation. Furthermore it is recommended that the instrument be recalibrated every year.

Two calibration modes are available: with BUCHI substances and user defined substances

### 6.4.1 Calibration principle

#### NOTE

The instrument is calibrated using melting point standards. The calibration is valid for boiling points as well. The calibration procedure is recommended to be performed with the BUCHI calibration substances, in the BUCHI calibration set mode.

Use the calibration set (11055018). This calibration set contains the melting point standards listed below. Each standard is shipped with a certificate of analysis and an MSDS (material safety data sheet).

The calibration set contains the following substances:

- 4-Nitrotoluene: approx. 52 °C
- Diphenyl acetic acid: approx. 148 °C
- Caffeine: approx. 237 °C
- Potassium nitrate: approx. 335 °C

From each substance, a minimum of 6 have to fulfill a standard deviation of less than +/- 0.2 °C. Otherwise the instrument will not move on to the next substance. The maximum number of samples for each substance to reach the deviation of +/- 0.2 °C is limited to 12 samples. The instrument automatically chooses the best 6 results from the determinations performed.

After a successful calibration is done, it may be checked using the verification set (11055019). Each standard of the set contains a certificate of analysis and the MSDS.

The verification set contains the following substances:

- Benzil: approx. 94 °C
- p-Anisic acid: approx. 182 °C
- Phenolphthalein: approx. 261 °C

#### NOTE FOR USER MANAGEMENT

The calibration procedure can only be performed in the administrator level.

## 6.4.2 Calibration procedure

To start calibration, turn the rotary knob to Calibration. With the select button the calibration principle can be chosen. Press START and follow the instruction on display.

BUCHI calibration set:

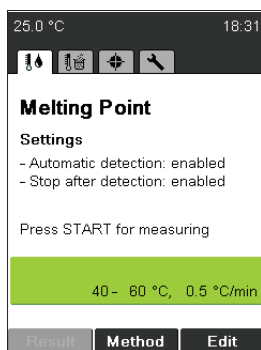

The instrument automatically heats to the start temperature of the first substance. In the meantime, prepare at least 6 samples of the given substance. For this process, follow section 6.2.1.



- Choose the correct pharmacopoeia melting point value with the rotary knob. The pharmacopoeia melting point is written on the certificate of analysis. Press Save.

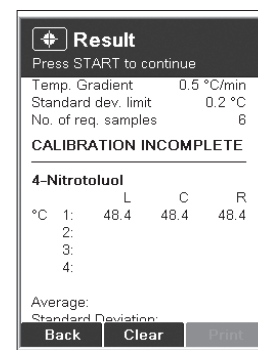

Follow the instructions on the display. After each run, the current result is indicated.

- Press START to perform the next measurement.

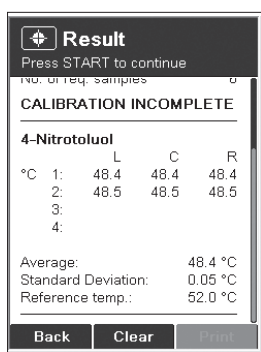

After 6 results are obtained within a standard deviation of +/- 0.2 °C, the process moves on to the next substance. The process is identical for the other substances.

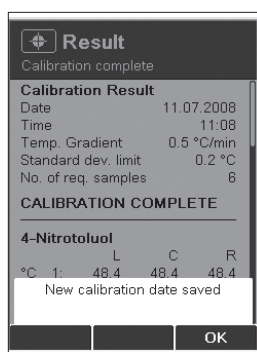

As soon as a complete calibration is obtained, the new calibration date is saved automatically.

- Press OK. All results obtained are displayed.

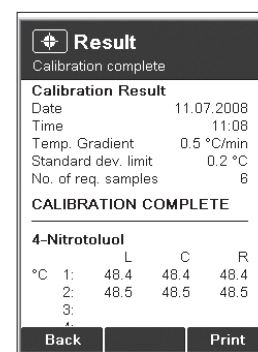

- The rotary knob can be used to display all the results of the calibration.
- The Print key is used to print out the data.
- Back exits this menu.

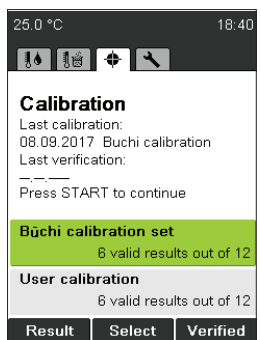

The calibration date is now saved and indicated on the idle screen.

User calibration:

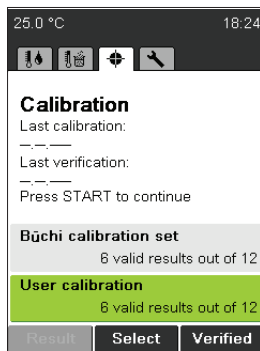

By choosing the user calibration, 4 freely selectable substances can be chosen for calibration.



Choose the gradient for the calibration with the rotary knob.

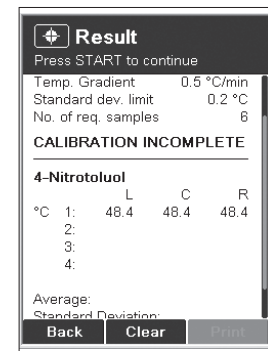

Insert the name of the substance with starting the lowest melting point used for the calibration.

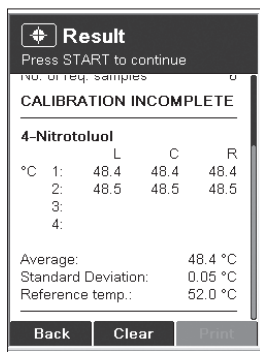

Set the melting point value for the substance using the rotary knob.

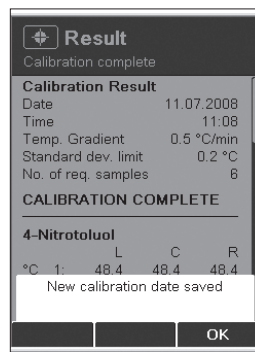

Enter the Lot number for the substance used.

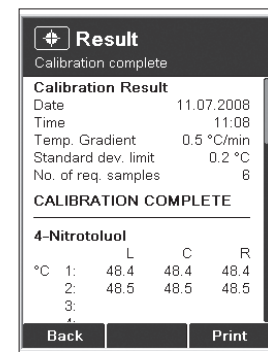

Enter the correct reference temperature for the substance according to the data sheet. This value is used for the actual calibration. Measurement as described for BUCHI calibration.

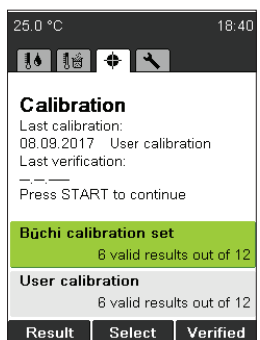

The calibration date is now saved and indicated on the idle screen..



## 6.4.3 Printout

①		<b>M-565</b>		<b>BUCHI</b>	
②		<b>Calibration</b>			
		Temp. gradient	0.5 °C/min		
		Standard deviation limit	0.2 °C		
		No. of required samples	6		
		<b>CALIBRATION COMPLETE</b>			
		<b>4-Nitrotoluene</b>			
		Auto (°C)	L	C	R
		1:	52.0	52.1	52.1
		2:	52.1	52.0	52.0
		3:			
		4:			
		Average:	52.1 °C		
		Standard deviation:	0.05 °C		
		Reference temperature:	52.0 °C		
		<b>Diphenylacetic Acid</b>			
		Auto (°C)	L	C	R
		1:	147.5	147.5	147.5
		2:	147.7	147.6	147.5
		3:			
		4:			
		Average:	147.6 °C		
		Standard deviation:	0.08 °C		
		Reference temperature:	147.6 °C		
		<b>Caffeine</b>			
		Auto (°C)	L	C	R
		1:	236.8	236.9	236.7
		2:	236.8	236.8	236.7
		3:			
		4:			
		Average:	236.8 °C		
		Standard deviation:	0.08 °C		
		Reference temperature:	236.8 °C		
		<b>Potassium Nitrate</b>			
		Auto (°C)	L	C	R
		1:	334.5	334.6	334.6
		2:	334.6	334.4	334.7
		3:			
		4:			
		Average:	334.6 °C		
		Standard deviation:	0.10 °C		
		Reference temperature:	334.5 °C		
		Date:	09.10.2008		
		Time:	11:16		
		<b>Date, Signature:</b>			
		SN:	V 00.22		

Printout

- ① Instrument type
- ② General information regarding calibration
- ③ Results 4-nitrotoluene
- ④ Results diphenylacetic acid
- ⑤ Results caffeine
- ⑥ Results potassium nitrate
- ⑦ General information
- ⑧ Signature of person making the calibration

## NOTE

The Average is calculated on the basis of the temperature values with two positions after the decimal point. Thus, the value indicated for the Average might deviate from the value you calculate on the basis of the temperature values on the printout, as there is just one position after the decimal point.

#### 6.4.4 Verification

To verify the calibration, proceed as follows:

- Measure all standards (BUCHI recommends using the verification set (11055019) but it is also possible to use your internal standards.

##### NOTE

The verification is not a guided process.

- When all measuring results were within the required tolerances, click on Verified. The following screen appears:

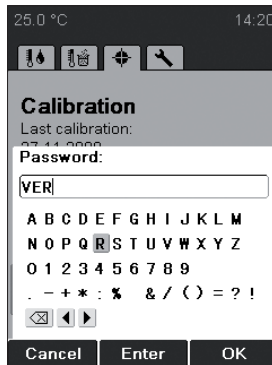

- Enter the following password: VER. The current date is now indicated under "Last verification".

##### NOTE FOR USER MANAGEMENT

Can only be accessed in the administrator level.

#### 6.5 Settings, SysInfo, Test

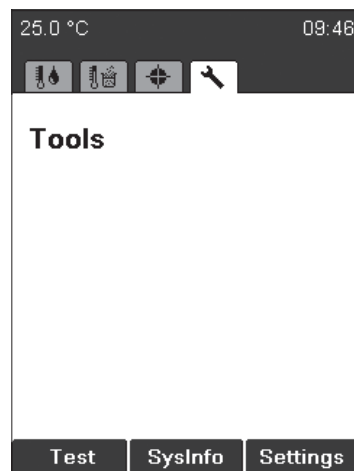

**Test:** Functional test of the instrument. To perform the test of several functions follow carefully the instruction on the screen. If a function test shows not ok, please contact the customer service. The Test protocol is described in section 6.5.1.

**SysInfo:** Instrument gives information regarding settings and connected devices.

**Settings:** This menu can be used to change parameters. The SysInfo protocol is described in section 6.5.2.

##### NOTE FOR USER MANAGEMENT

Can only be accessed in the administrator level.

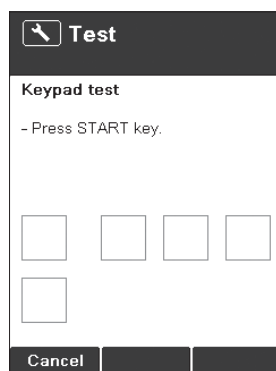

- Press the Test button to enter the functional test, and follow the instructions.

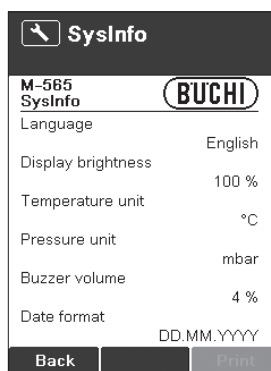

- Press the SysInfo button to open the system information menu.

Printout is possible if a printer is connected.

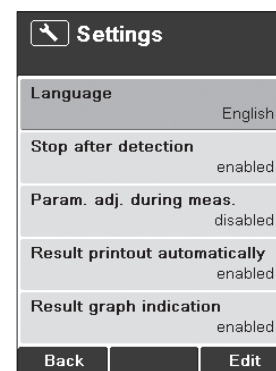

- Press the Settings button to enter the settings menu.

**Table 6-1: Setting parameters**

Language	English, German, French, Italian, Spanish, Japanese, Chinese
Stop after detection	disabled, enabled: If the instrument finds a melting point or boiling point for every detected sample, measurement stops automatically.
Param. adj. during meas.	disabled, enabled: Whether or not it is possible to change parameters (start temperature, stop temperature, and temperature gradient) during a determination.
Result printout automatically	disabled, enabled: After a measurement is finished, results will be printed automatically.
Result graph indication	disabled, enabled: Each result contained is shown with a graphic.
Calibration interval	0–36 months: default 12 months. BUCHI recommends calibration or verification after 12 months using the calibration set and the verification set.
Sample ID request	enabled: After the start of determination, the sample ID window is displayed. disabled: The sample ID window is not automatically displayed. In combination with the Melting Point Monitor software, it is advisable to turn this feature off.
Barometric pressure request	Has impact only on boiling point determination. never: No pop-up screen is shown. daily: Enter current barometric pressure once a day. always: Enter current barometric pressure every time the instrument heats up to the start temperature for boiling point determination.
Boiling sample conditioning	0–600 s: The default value is set to 60 seconds. This is needed to ensure temperature equilibrium between heating block and liquid in the boiling point tube. If this value is set too low, the result can be incorrect or no automatic boiling point detection.
Melting result	acc. pharmacopoeia thermodynamic range

**Table 6-1: Setting parameters (cont.)**

Thermodynamic correction	0.0–3.0; default value: 1.1
Company name	The name of a company can be entered.
Date (DD.MM.YYYY)	XX.XX.XXXX
Time (24 h)	XX:XX
Date format	DD.MM.YYY, MM/DD/YYYY, YYYY-MM-DD
Time format	24 h, AM/PM
Temperature unit	°C, °F, K
Buzzer volume	0, 1, 2, 3, 4
External Keyboard	CH, USA
Display brightness	0–100%
Automatic detection	Enable or disable the automatic detection. If disabled, stop temperature of method is the end of the determination.
Statistic	Enable or disable the statistic. If disabled, mean value and standard deviation are not shown in the results.
Camera position	Use the rotary knob to position the dashed rectangles at the bottom part of the substance according to the example.

Change Direction to move vertically or horizontally.

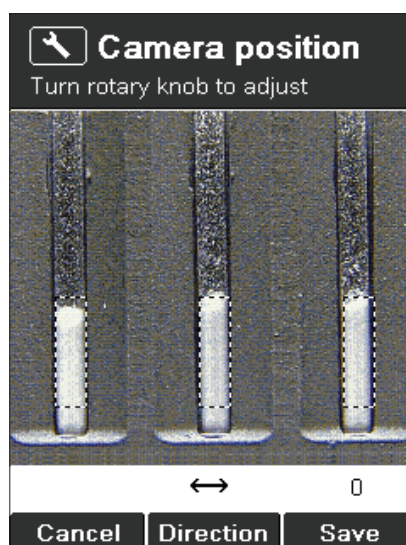

User management	Activation key will enable the user management setting. After an administrator password can be defined. The instrument can only be started in the administrator mode if the correct password is entered.
-----------------	--

## 6.5.1 Test protocol

<b>M-565</b>		<b>BUCHI</b>
<b>Test Result</b>		
①	Keypad	OK
	Rotary knob	OK
	24V input voltage	OK
	24V after fuse	OK
	5V	OK
	Heating present	OK
	Cooling fan present	OK
	Housing fan present	OK
	Temp. sensor present	OK
	Temp. sensor function	OK
	External keyboard	OK
	Board temp. sensor	OK
	Heating function	OK
	Cooling fan	OK
	Housing fan	OK
	Sample illumination	OK
	Camera position	OK
	Camera brightness	OK
	Internal clock	OK
	Display	OK
②	Cam. value w/o samp. L	14
	Cam. value w/o samp. C	15
	Cam. value w/o samp. R	18
	Cam. value w/ samp. L	108
	Cam. value w/ samp. C	114
	Cam. value w/ samp. R	112
③	<b>Date, Signature:</b>	
	SN:	V 01.05

- ① Power supply voltage
- ② Values for sample brightness
- ③ Signature of person carrying out the test

## 6.5.2 SysInfo protocol

M-565 SysInfo		<b>BUCHI</b>
<b>Settings</b>		
Language		English
Stop after detection		enabled
Param. adjust. during meas.		enabled
Result printout automatically		enabled
Result graph indication		enabled
Calibration interval		12 Months
Sample ID request		enabled
Barometric pressure request		always
Boiling sample conditioning		30 s
Melting result		acc. pharmacopoeia
Thermodynamic factor		1.1
Company name		
Date (DD.MM.YYYY)		12.01.2010
Time (24 h)		07:57
Date format		DD.MM.YYYY
Time format		24 h
Temperature unit		°C
Pressure unit		mbar
Buzzer volume		4
External keyboard		CH
Display brightness		100 %
Automatic detection		enabled
Statistic		enabled

① Setting parameters

<b>Service</b>	
Serial number	1000005820
Firmware version	01.05.11
Version CPLD	00.15
Operating hours	576392.8 h
No. of melting point meas.	97
No. of boiling point meas.	22
Number of calibrations	14
Calibration date	20.03.2009
Verification date	16.02.2009
Factory adj. value at 20°C	-0.28 °C
Calibration value at 52°C	-0.04 °C
Calibration value at 148°C	-0.54 °C
Calibration value at 237°C	1.46 °C
Calibration value at 335 °C	2.62 °C
Factory adj. value at 400°C	3.27 °C
Sample illumin. brightness	100 %
Camera position horizontally	30
Camera position vertically	-5
Color gain green for meltingp.	140
Color gain blue for meltingp.	205
Color gain red for meltingp.	110
Color gain green for boilingp.	75
Color gain blue for boilingp.	110
Color gain red for boilingp.	60
Board test date	--.--
End test date	--.--
Board temperature	42 °C
Heating present	OK
Cooling fan present	OK
Housing fan present	OK
Temp. sensor present	OK
Temp. sensor function	OK
24V before fuse present	OK
24V after fuse present	OK
5V present	OK
<b>Date, Signature:</b>	
SN:	V 01.05

② Correction values for calibration

③ Camera position values

④ Color values (Factory default settings)

⑤ Date of the factory tests

⑥ Signature of the person who performed the test

## 6.6 User management

An optional user management (11066387) is available to provide regulatory compliance. A serial number dependent activation code has to be entered in the settings menu. After entering the activation code, a password to enter the administrator level can be defined.

With the user management a password identification is requested when switching on the instrument.

- If the password is successfully entered, the user gets access to the administrator level.
- Without password identification or the wrong password the user has limited access to the instrument functionalities.

### Administrator level

1. Full access to the instrument functionalities
2. Access to the Service menu
3. Possibility to change the password
4. Connection to MeltingPoint Monitor Software possible

### User level

1. Possibility to choose between melting point and boiling point
2. Access to the following parameters: start temperature, heating rate and end temperature
3. Selection of methods, but no editing and deleting
4. No access to: changing of date and time, calibration data and calibration menu.
5. No connection to: MeltingPoint Monitor Software

The user management setting for the password protection can be undone by deleting the password in the administrator mode and leaving the field blank. The user management setting can be reactivated with the activation key.

The activation key is only valid in the year of purchase.

For later activation please contact: [registration@buchi.com](mailto:registration@buchi.com)

## 6.7 XML to PC data export

If no printer is connected to the MeltingPoint device, data can be sent to a PC by pushing the "XML2PC" button. The raw data is transmitted through the serial interface and can be received by the PC with the following settings:

**Table 6-7: PC settings**

Baud rate:	19200
Parity:	No
Data bit:	8
Stop bit:	1

No PC software is supplied to receive the XML data.

Picking up the data is the customers responsibility.



## 7 Maintenance

This section provides instructions on all maintenance work to be performed to keep the instrument in good working condition.



### WARNING

All maintenance and repair work requiring the opening or removal of the instrument housing must be carried out by trained personnel and only with the tools provided for this purpose.



### WARNING

Electrical hazard:

- Prior to any maintenance work on the instrument, switch off the power supply.



### ATTENTION

Use only genuine BUCHI consumables and spare parts for any maintenance and repair work in order to assure continued system performance and reliability. Any modifications to the spare parts used should be carried out only with the prior written permission of the manufacturer.

### 7.1 Housing

Check the housing of your melting point instrument for defects (controls, plugs). The housing is coated with paint and should be cleaned only with a rag moistened in a soapy solution.

Remove the glass window from the heating block periodically and wipe it clean with alcohol or acetone. Replace the window with a new one if it will not come completely clean.

### ATTENTION



Never use any halogenated solvents, acetone, or similar chemicals, because such cleaning agents may damage the instrument.

### 7.2 Glass window

Remove the glass window from the heating block periodically and wipe it clean with alcohol or acetone. Replace the window with a new one if it will not come completely clean.

### 7.3 Upkeep

The upkeep of the unit is mainly limited to:

- Periodic calibration of the temperature.

## 7.4 Cleaning the heating block

Remove broken capillaries from the heating block.

### ATTENTION



- Wait for the heating block to cool down before touching it!
- Remove the cover.

Follow the instructions mentioned below on the use of the cleaning tool 051978.



- If a melting point capillary is broken and is stuck in the heating block, use the cleaning tool (Order number: 051978).



- Remove the cover and glass holder with glass window.



- If glass parts of a melting point capillary are stuck in a hole of the metal heating block, use the cleaning tool as shown in the picture.

## 8 Troubleshooting

The following section describes how to resume operation of the instrument in the event of any minor problem. It lists some possible occurrences, their probable cause, and suggests how to remedy the problem. The troubleshooting table below lists possible instrument malfunctions and errors and describes courses of action that can be used by operators to correct some of those problems. The appropriate course of action is listed in the column "Remedy".

More complicated malfunctions or errors are usually handled by a BUCHI technical engineer who has access to the official service manuals. In this case, please contact your local BUCHI customer service agent.

### 8.1 Malfunctions and their remedy

<b>Table 8-1: General malfunctions and their remedy</b>		
Malfunction	Possible cause	Remedy
Instrument does not work	Main switch off	Switch on mains switch
	Instrument is not connected to mains supply	Check mains connection
No or unreadable printout	Not activated in the settings	Activate automatic printout in the settings
	Bad cable connection	Check cable connection
	Printer switched OFF	Switch ON printer
	No paper	Replace paper roll
	Baud rate settings of printer faulty	See section 8.1.1
No melting curve is shown	Not activated in the settings	Activate graphic in the settings
	No automatic detection of samples	Manually register the melting point/boiling point
	Measuring finished before detecting a result for all samples	Turn off in the settings "Stop after detection" and check stop temperature.
In the automatic melting point determination, no value and no melting curve are determined	Sample is unstable, it decomposes, turns brown, or melts non-uniformly	e.g. select higher maximum point
	The temperature parameters have been entered incorrectly and the sample does not melt at all	
	Automatic detection is disabled	Enable the Automatic detection in the Settings
Sometimes no results or only 1 or 2 results instead of 3 results	START button was pressed before insertion of all sample capillaries	Put all sample capillaries in the oven first, then press the START button. Do not move the sample capillaries again.
Unexpected results	Sample-specific preparations: Sample is not dry or is contaminated by another substance	Sample should be dried before use

**Table 8-1: General malfunctions and their remedy**

Malfunction	Possible cause	Remedy
	Sample decomposes during the melting process (formation of bubbles, sample turns brown, etc.)	
	Apparatus parameters: Apparatus is not or is poorly calibrated Method "According to pharmacopoeia" or "thermodynamic melting point determination" is incorrectly selected	Regular calibration of apparatus with BUCHI calibrating substances Alter the corresponding parameters
No results	Setting point is too close to the melting point	Select setting point 5–10 °C below melting point
No statistic	Setting parameter Statistic is disabled	Enable the Statistic in the Settings
Instrument does not heat	Heating defective	Contact BUCHI customer service.

**Table 8-2: Malfunctions with Melting Point Monitor software**

Malfunction	Possible cause	Remedy
No USB connection	USB cable is not connected or defective.	Check USB connection, replace if necessary.
Driver not found	Device connected for the first time.	Install recommended driver.

**Table 8-3: Warning messages**

Warning number	Possible cause	Remedy
Warning 01	Calibration outdated.	Calibrate or verify device.
Warning 02	Housing temperature too high.	Cool down device and check clearance of vent holes and fans. Check ambient temperature.
Warning 03	Device not calibrated.	Calibrate device.

**Table 8-4: Error messages**

Error number	Possible cause	Remedy
Error 01	Memory data loss, all data are reset.	Calibrate device. In case of recurrence contact customer service.
Error 02	Automatic restart, firmware problem possible.	In case of recurrence contact customer service.
Error 03	Board temperature sensor defective.	Contact customer service.
Error 04	Temperature sensor defective.	Contact customer service.
Error 05	Heating defective.	Contact customer service.
Error 06	Cooling fan defective.	Contact customer service.
Error 07	Housing fan defective.	Contact customer service.
Error 08	Camera defective, communication loss.	Contact customer service.
Error 09	24 V fuse defective.	Contact customer service.
Error 10	24 V input voltage missing.	Contact customer service.

**Table 8–4: Error messages**

Error number	Possible cause	Remedy
Error 11	Internal clock, power loss.	Contact customer service.
Error 13	5V input voltage missing	Contact customer service.

**NOTE**

If several errors are pending, the one with the highest priority will be displayed.

## 8.1.1 Setting the printer baud rate

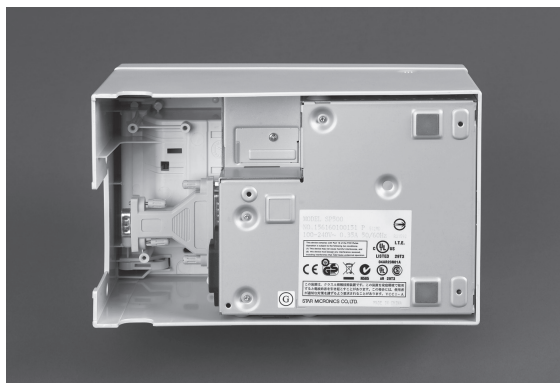

- Open compartment on the bottom of the printer.

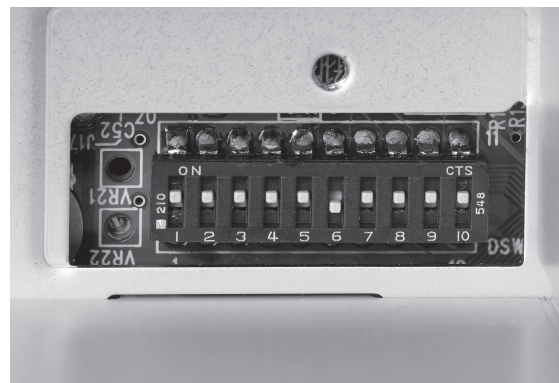

- The following setting should be selected.  
1,2,3,4,5,7,8,9,10 = ON  
6 = OFF

## 8.2 Customer service

Only authorized service personnel are allowed to perform repair work on the instrument. They have comprehensive technical training and knowledge of possible dangers that might arise from the instrument.

Contacts for official BUCHI customer service offices are available on the BUCHI website at: [www.buchi.com](http://www.buchi.com). If malfunctions occur on your instrument or you have technical questions or application problems, please contact one of these offices.

Customer Service offers the following:

- Spare part delivery
- Repairs
- Technical advice

## 9 Shutdown, storage, transport, and disposal

This section provides instructions on how to shut down the instrument, how to pack it for storage or transport, and specifies the storage and shipping conditions.

### 9.1 Storage and transport



WARNING  
Biohazard:

- Remove all dangerous substances from the instrument, and clean it thoroughly.
- Store and transport the instrument in its original packaging.



WARNING  
Electrical hazard:

- Always remove the power cord from the socket first to avoid having live cables in the laboratory.

### 9.2 Disposal

To dispose of the instrument in an environmentally friendly manner, a list of materials is given in section 3.3, please ensure that the components are separated and recycled correctly. Please follow current regional and local laws concerning disposal.

## 10 Spare parts

This section lists spare parts, accessories, and optional extras, including all of the relevant order information for ordering from BUCHI. Always state the product designation and part number when ordering any spare parts.

To ensure optimum system performance and reliability, use only genuine BUCHI consumables and spare parts for maintenance and repair. Prior written permission of the manufacturer should be obtained before any modifications are made to the spare parts used.

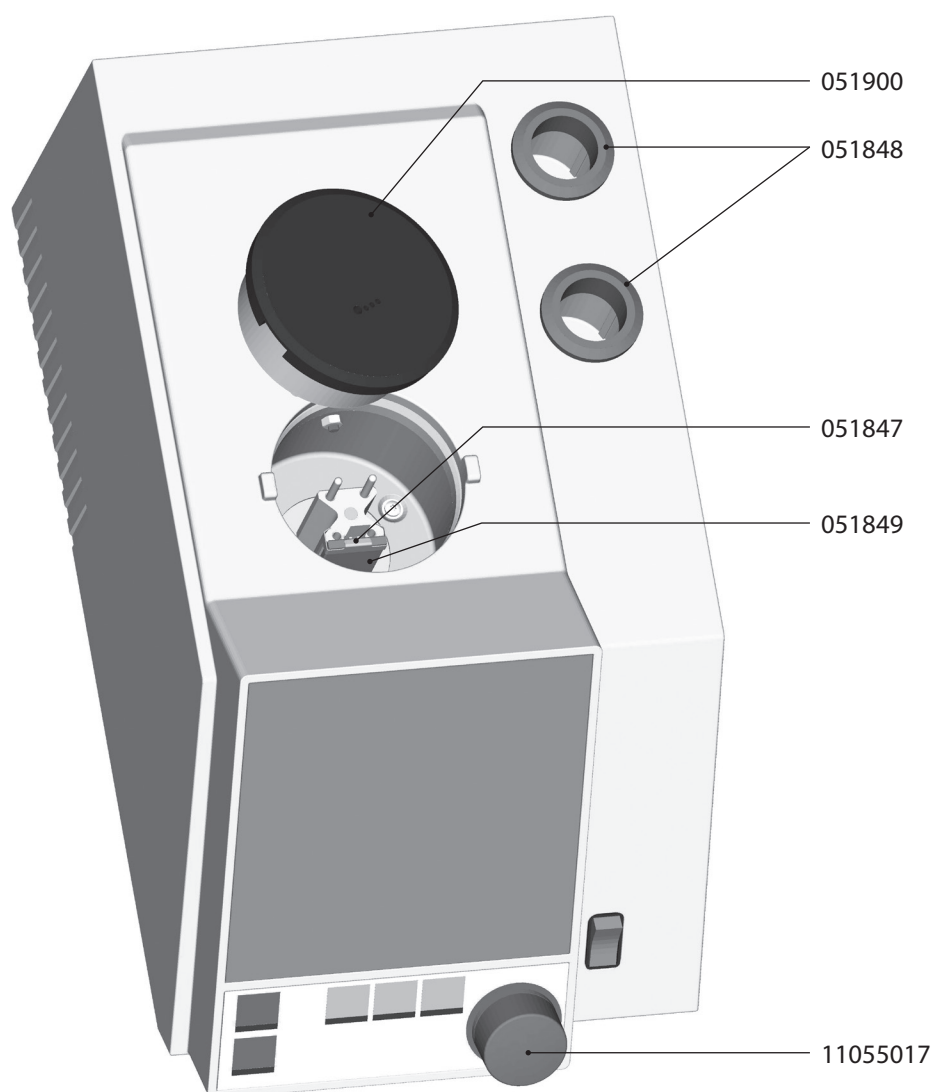

Fig. 10.1: Spare parts

**Table 10-1: Spare parts**

Product	Order number	Product	Order number
Cover	051900	Ring	051848
Glass holder	051847	Rotary knob	11055017
Glass window	051849		

## 11 Declarations and requirements

### 11.1 FCC requirements (for USA and Canada)

English:

This equipment has been tested and found to comply with the limits for a Class A digital device, pursuant to both Part 15 of the FCC Rules and the radio interference regulations of the Canadian Department of Communications. These limits are designed to provide reasonable protection against harmful interference when the equipment is operated in a commercial environment.

This equipment generates, uses, and can radiate radio frequency energy and, if not installed and used in accordance with the instruction manual, may cause harmful interference to radio communications. Operation of this equipment in a residential area is likely to cause harmful interference, in which case users will be required to correct the interference at their own expense.

Français:

Cet appareil a été testé et s'est avéré conforme aux limites prévues pour les appareils numériques de classe A et à la partie 15 des réglementations FCC ainsi qu'à la réglementation des interférences radio du Canadian Department of Communications. Ces limites sont destinées à fournir une protection adéquate contre les interférences néfastes lorsque l'appareil est utilisé dans un environnement commercial.

Cet appareil génère, utilise et peut irradier une énergie à fréquence radioélectrique, il est en outre susceptible d'engendrer des interférences avec les communications radio, s'il n'est pas installé et utilisé conformément aux instructions du mode d'emploi. L'utilisation de cet appareil dans les zones résidentielles peut causer des interférences néfastes, auquel cas l'exploitant sera amené à prendre les dispositions utiles pour palier aux interférences à ses propres frais.





## BUCHI Affiliates:

### Europe

#### Switzerland/Austria

**BÜCHI Labortechnik AG**  
CH – 9230 Flawil  
T +41 71 394 63 63  
F +41 71 394 64 64  
buchi@buchi.com  
www.buchi.com

#### Italy

**BUCHI Italia s.r.l.**  
IT – 20010 Cornaredo (MI)  
T +39 02 824 50 11  
F +39 02 575 12 855  
italia@buchi.com  
www.buchi.com/it-it

#### Benelux

**BÜCHI Labortechnik GmbH**  
Branch Office Benelux  
NL – 3342 GT Hendrik-Ido-Ambacht  
T +31 78 684 94 29  
F +31 78 684 94 30  
benelux@buchi.com  
www.buchi.com/bx-en

#### Russia

**BUCHI Russia/CIS**  
Russia 127287 Moscow  
T +7 495 36 36 495  
russia@buchi.com  
www.buchi.com/ru-ru

#### France

**BUCHI Sarl**  
FR – 94656 Rungis Cedex  
T +33 1 56 70 62 50  
F +33 1 46 86 00 31  
france@buchi.com  
www.buchi.com/fr-fr

#### United Kingdom

**BUCHI UK Ltd.**  
GB – Oldham OL9 9QL  
T +44 161 633 1000  
F +44 161 633 1007  
uk@buchi.com  
www.buchi.com/gb-en

#### Germany

**BÜCHI Labortechnik GmbH**  
DE – 45127 Essen  
T +800 414 0 414 0 (Toll Free)  
T +49 201 747 49 0  
F +49 201 747 49 20  
deutschland@buchi.com  
www.buchi.com/de-de

#### Germany

**BÜCHI NIR-Online**  
DE – 69190 Walldorf  
T +49 6227 73 26 60  
F +49 6227 73 26 70  
nir-online@buchi.com  
www.nir-online.de

### America

#### Brazil

**BUCHI Brasil Ltda.**  
BR – Valinhos SP 13271-200  
T +55 19 3849 1201  
F +55 19 3849 2907  
brasil@buchi.com  
www.buchi.com/br-pt

#### USA/Canada

**BUCHI Corporation**  
US – New Castle, DE 19720  
T +1 877 692 8244 (Toll Free)  
T +1 302 652 3000  
F +1 302 652 8777  
us-sales@buchi.com  
www.buchi.com/us-en

### Asia

#### China

**BUCHI China**  
CN – 200233 Shanghai  
T +86 21 6280 3366  
F +86 21 5230 8821  
china@buchi.com  
www.buchi.com/cn-zh

#### India

**BUCHI India Private Ltd.**  
IN – Mumbai 400 055  
T +91 22 667 75400  
F +91 22 667 18986  
india@buchi.com  
www.buchi.com/in-en

#### Indonesia

**PT. BUCHI Indonesia**  
ID – Tangerang 15321  
T +62 21 537 62 16  
F +62 21 537 62 17  
indonesia@buchi.com  
www.buchi.com/id-in

#### Japan

**Nihon BUCHI K.K.**  
JP – Tokyo 110-0008  
T +81 3 3821 4777  
F +81 3 3821 4555  
nihon@buchi.com  
www.buchi.com/jp-ja

#### Korea

**BUCHI Korea Inc.**  
KR – Seoul 153-782  
T +82 2 6718 7500  
F +82 2 6718 7599  
korea@buchi.com  
www.buchi.com/kr-ko

#### Malaysia

**BUCHI Malaysia Sdn. Bhd.**  
MY – 47301 Petaling Jaya,  
Selangor  
T +60 3 7832 0310  
F +60 3 7832 0309  
malaysia@buchi.com  
www.buchi.com/my-en

#### Singapore

**BUCHI Singapore Pte. Ltd.**  
SG – Singapore 609919  
T +65 6565 1175  
F +65 6566 7047  
singapore@buchi.com  
www.buchi.com/sg-en

#### Thailand

**BUCHI (Thailand) Ltd.**  
TH – Bangkok 10600  
T +66 2 862 08 51  
F +66 2 862 08 54  
thailand@buchi.com  
www.buchi.com/th-th

## BUCHI Support Centers:

#### South East Asia

**BUCHI (Thailand) Ltd.**  
TH-Bangkok 10600  
T +66 2 862 08 51  
F +66 2 862 08 54  
bacc@buchi.com  
www.buchi.com/th-th

#### Middle East

**BÜCHI Labortechnik AG**  
UAE – Dubai  
T +971 4 313 2860  
F +971 4 313 2861  
middleeast@buchi.com  
www.buchi.com

#### Latin America

**BUCHI Latinoamérica S. de R.L. de C.V.**  
MX – Mexico City  
T +52 55 9001 5386  
latinoamerica@buchi.com  
www.buchi.com/es-es

We are represented by more than 100 distribution partners worldwide.  
Find your local representative at: [www.buchi.com](http://www.buchi.com)